

## SKY ROYAL PALACE HP308



CP-ASSY-HP308#-A1-20230404

### Installation Reminder

- Prepare tools:

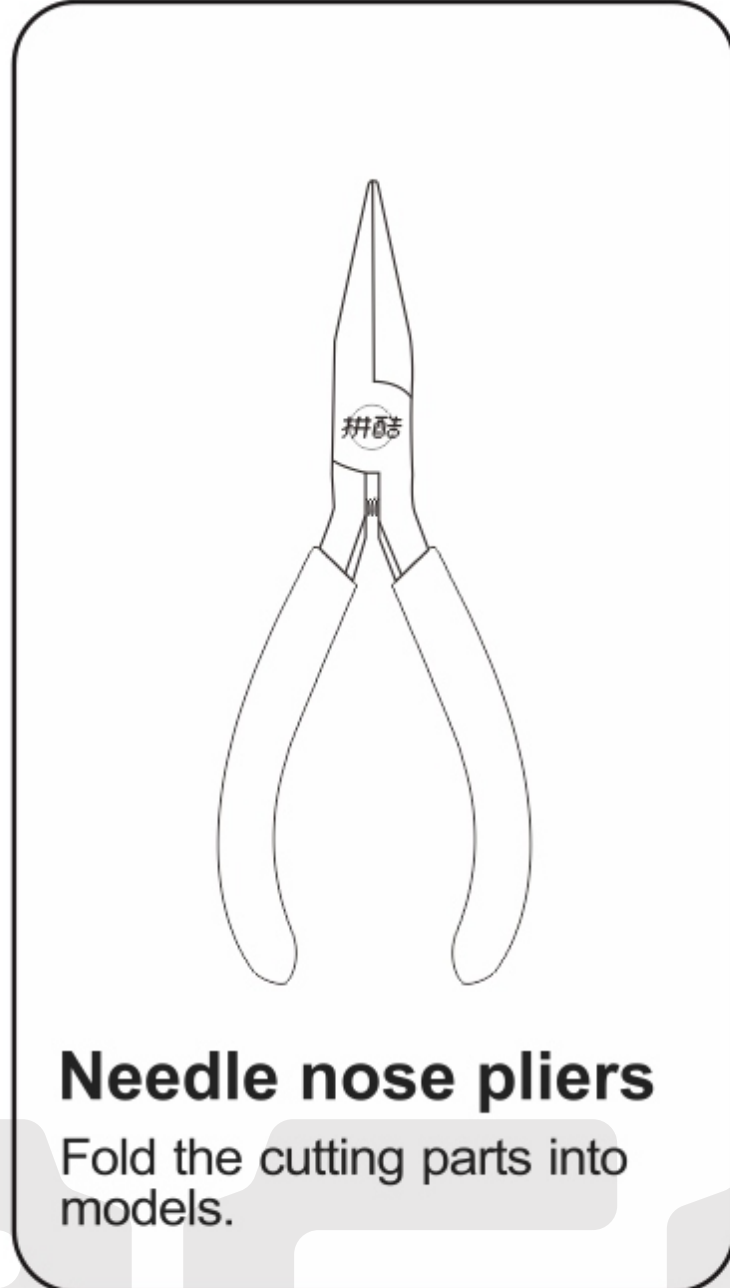
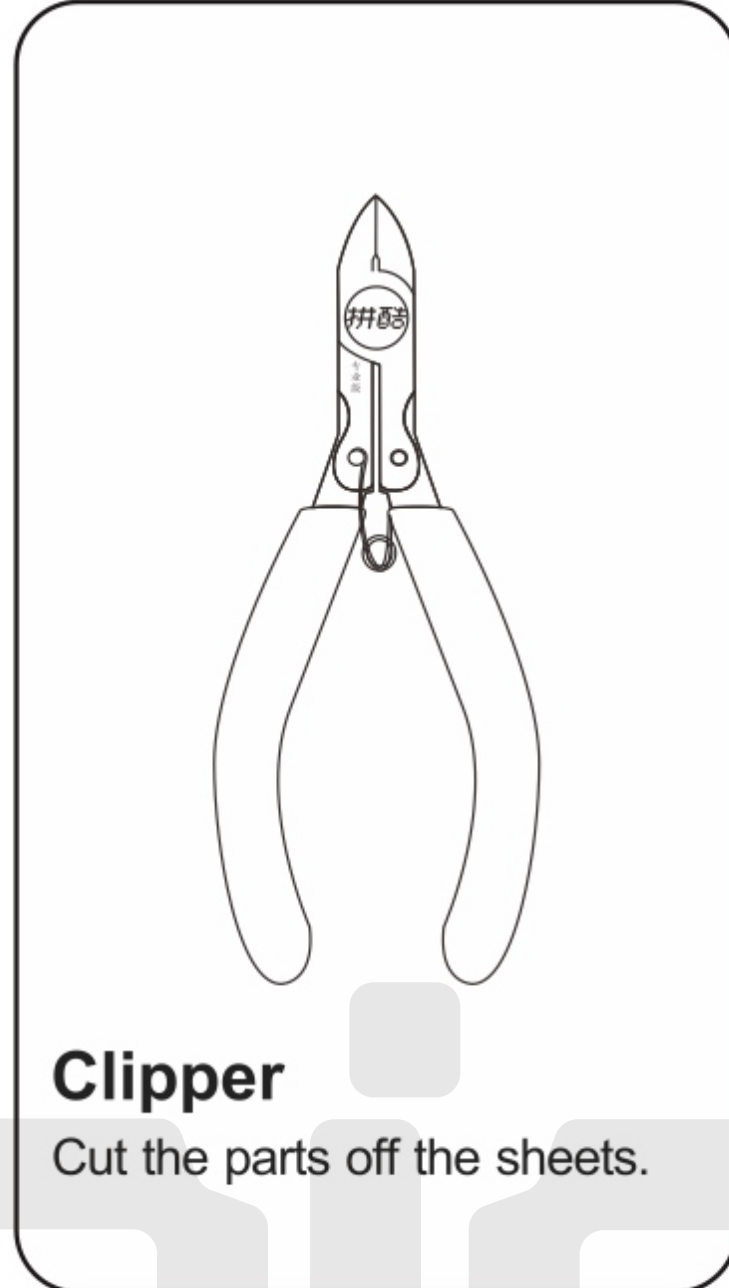

It is recommended to use piececool authentic assembly tools to build or fix the design. It is tailor made for the metal pieces and user friendly.

**WARNING** – Please handle metal sheets with care. The parts may have sharp edges that could cut or scratch skin. Keep away from children.

- Installation Method:

#### a. Remove the parts

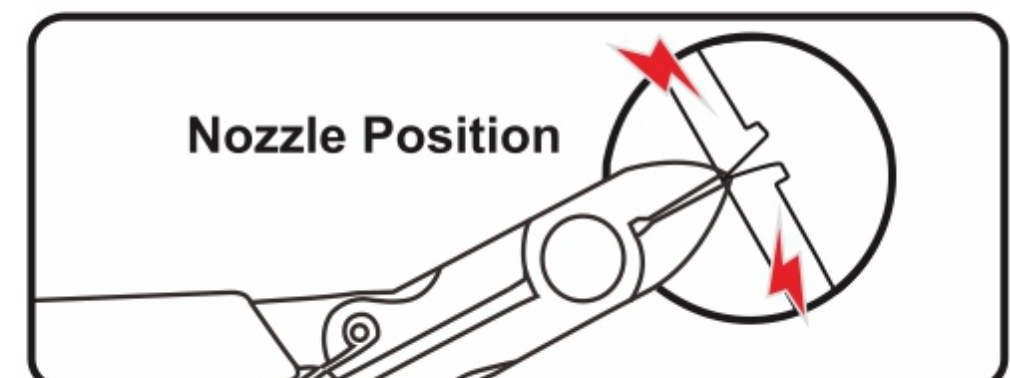

Please use the clipper to cut the nozzle position and remove the parts.

#### b. Identify the parts

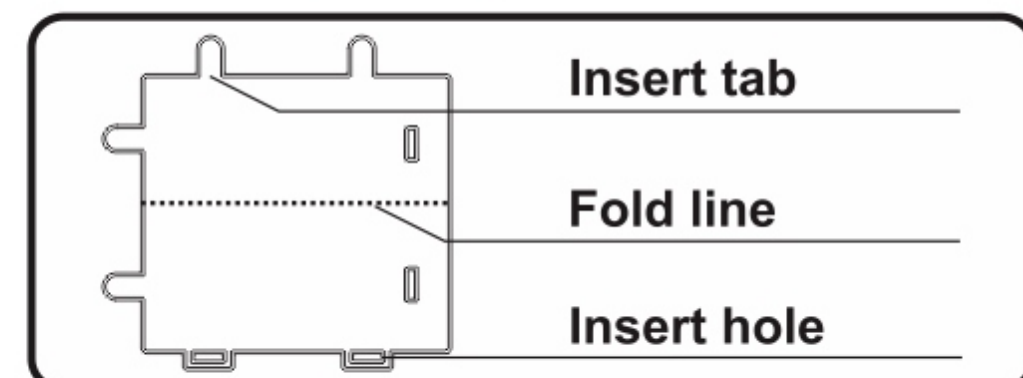

Identify the insert tab, fold line and the insert hole.

#### c. Folding the parts

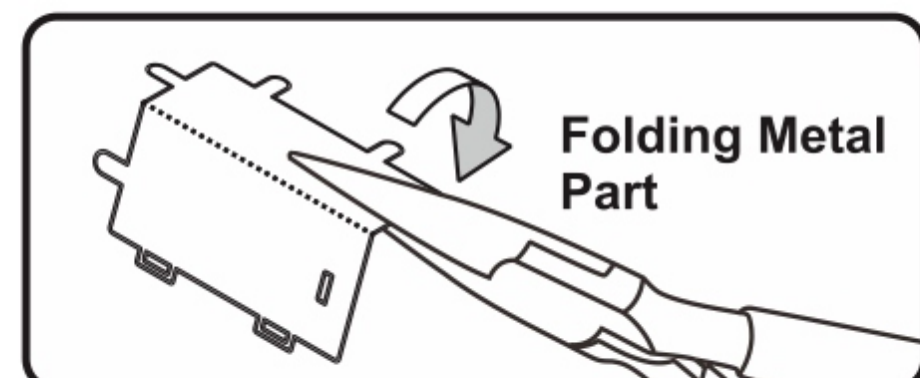

Please use the needle nose pliers to fold the cutting parts into models.

#### d. Retaining the parts

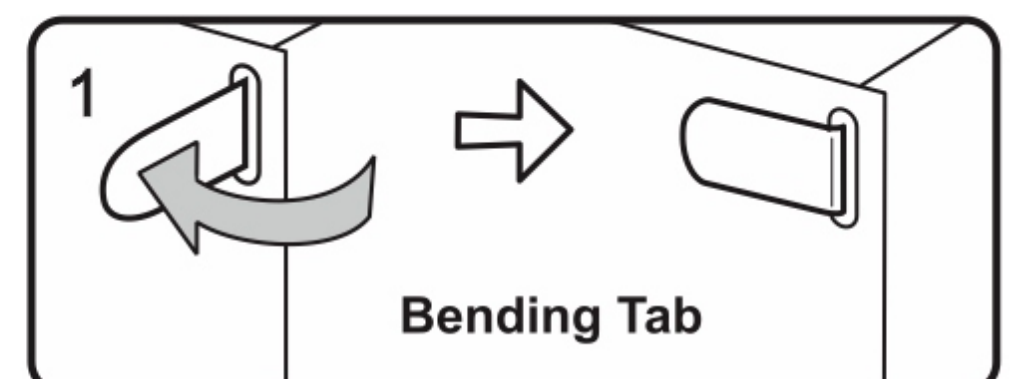

Insert the hole, bending tab with angle 90°

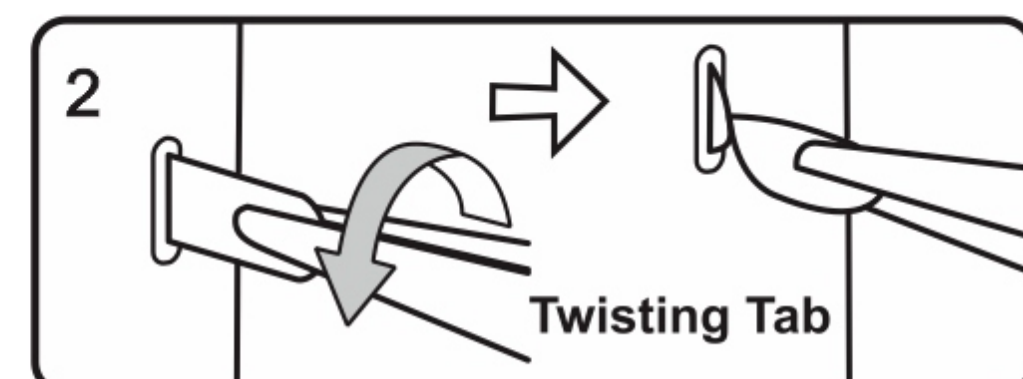

Insert the hole, twisting tab with angle 90°

- Attention:

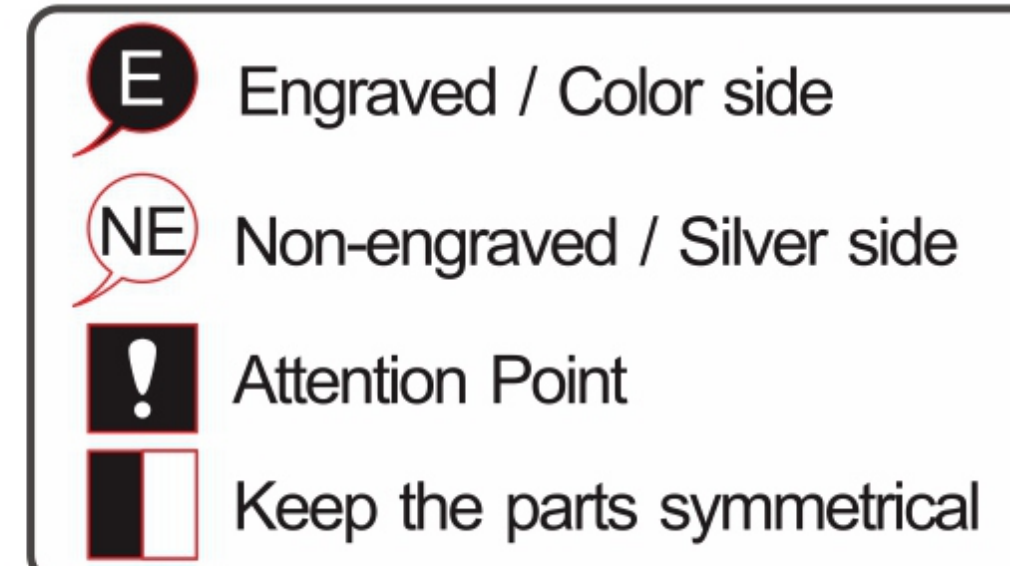

When cutting metal parts, please do not cut the "insert tab" as "nozzle position". Only cut the parts of the current step when cutting the parts. Do not cut all the parts at one time to avoid loss.

When encountering the parts of the folding line, please pay attention to the front and back of the metal sheet and the direction of the folding. According to the direction indicated in the instruction, cut lightly and fold slowly. It is best to fold it once. Do not fold it repeatedly to avoid damage to the parts.

### Assembly Guide

#### Step 01

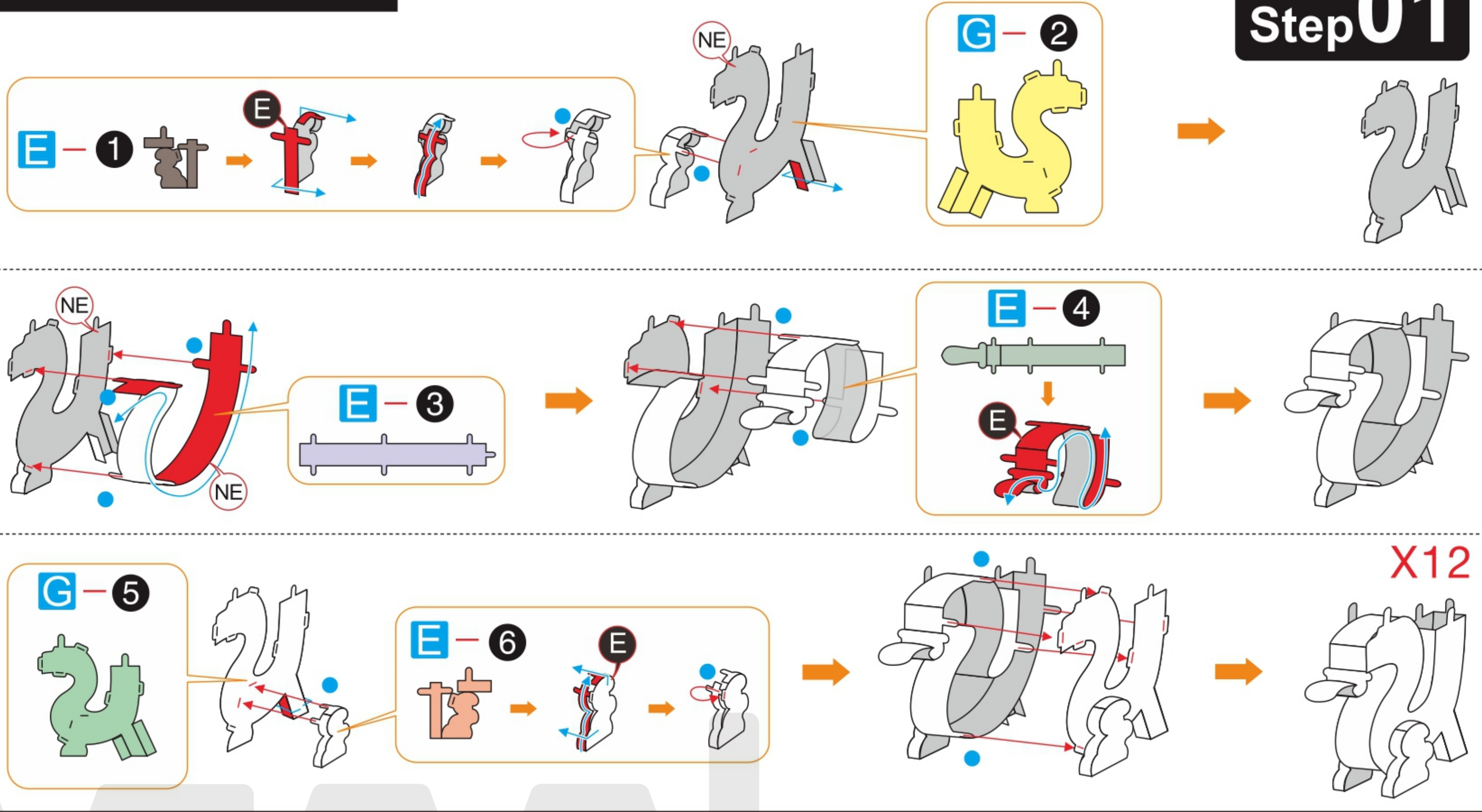

#### Step 02

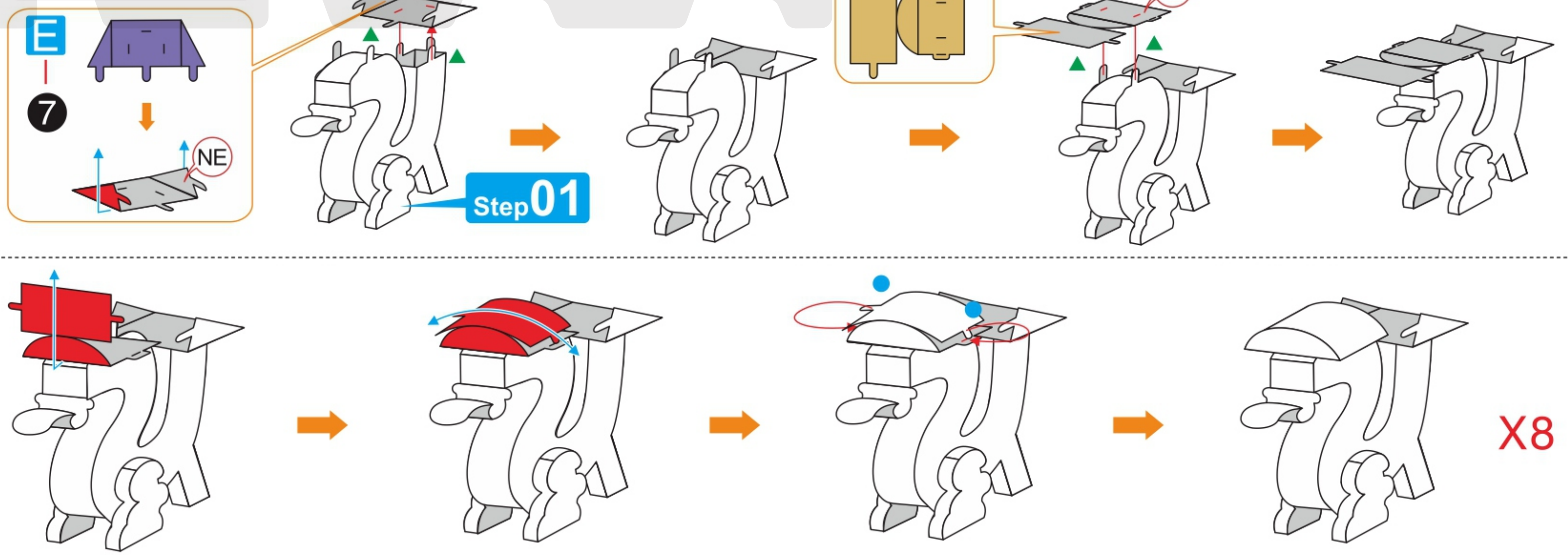

#### Step 03

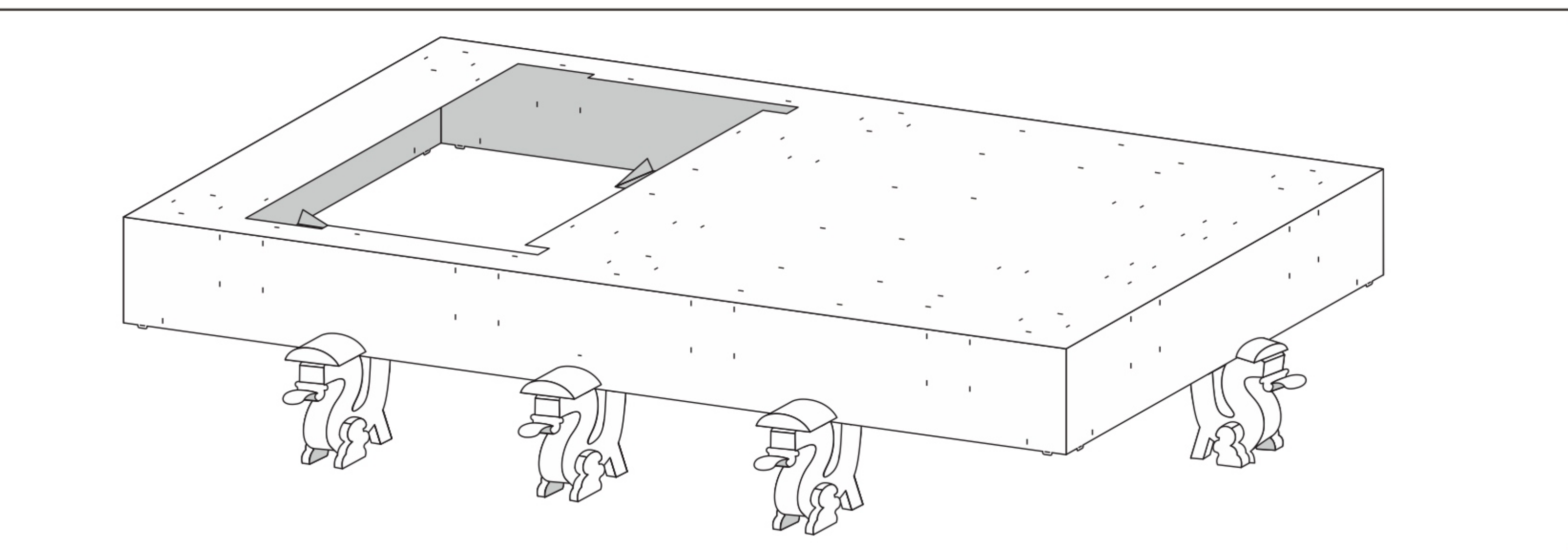
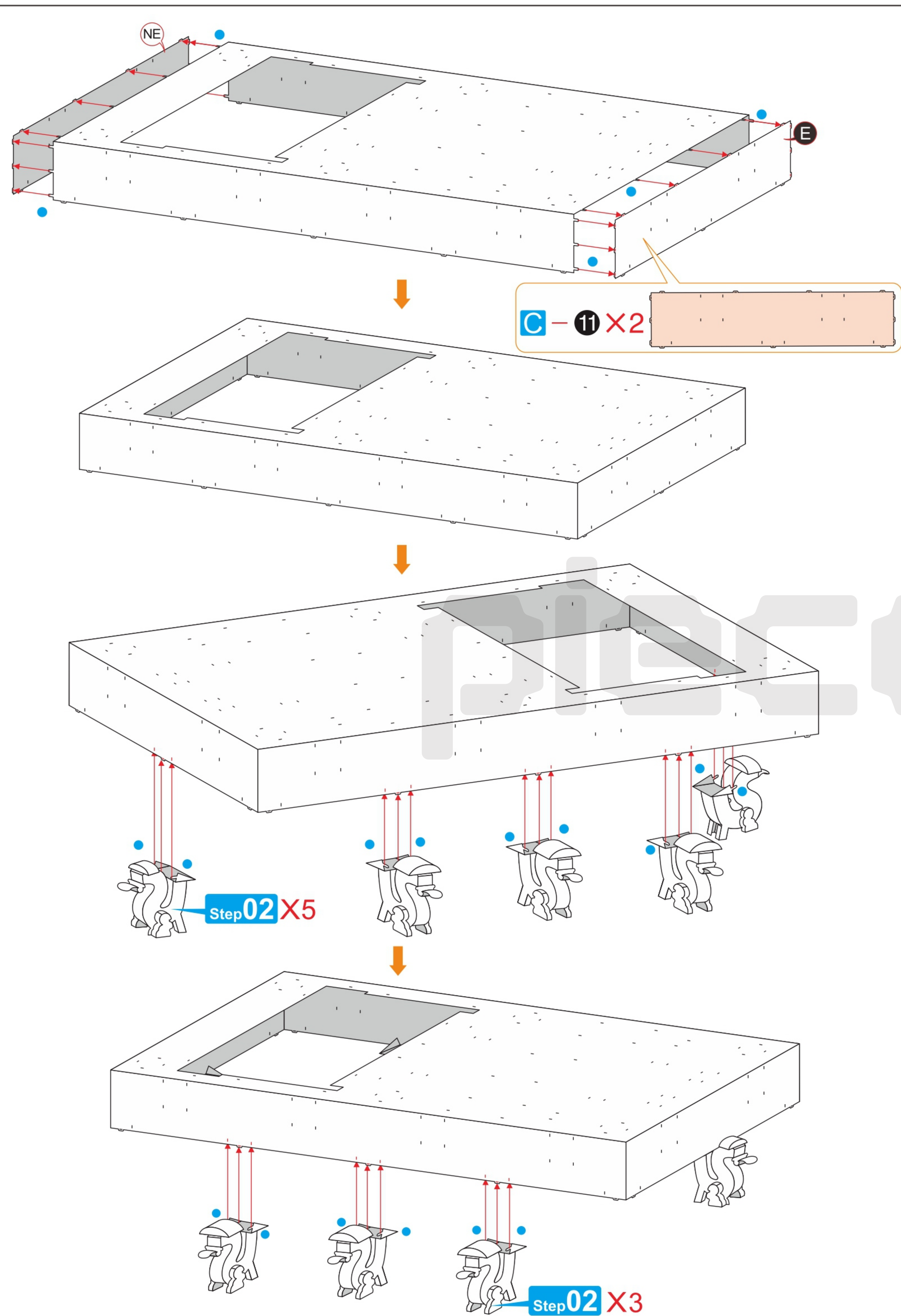
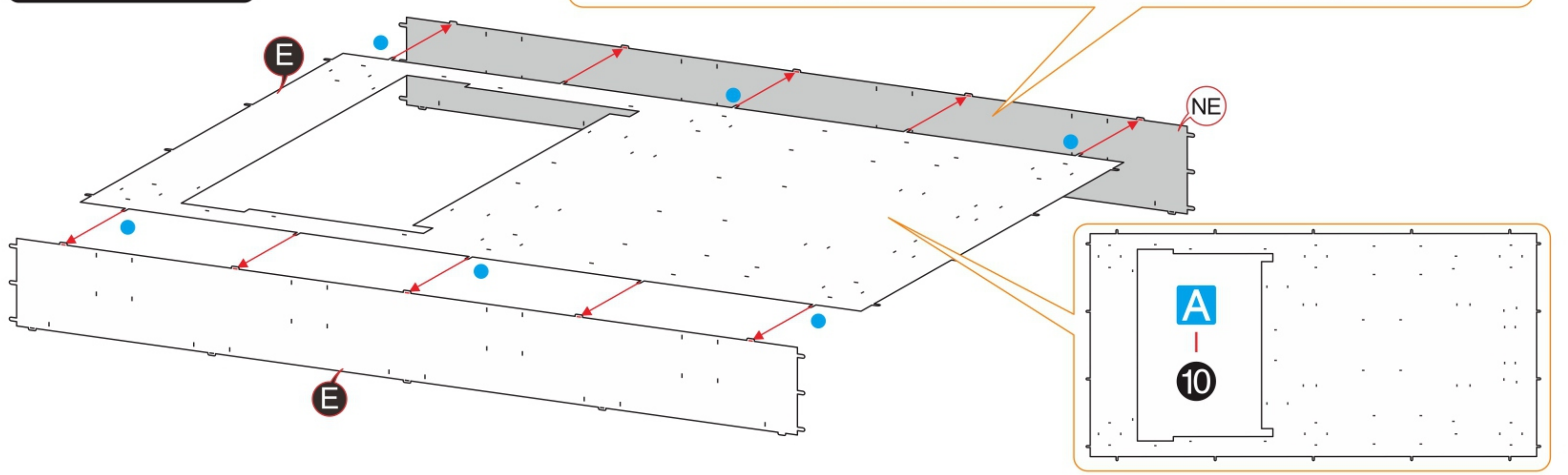

#### Step 04

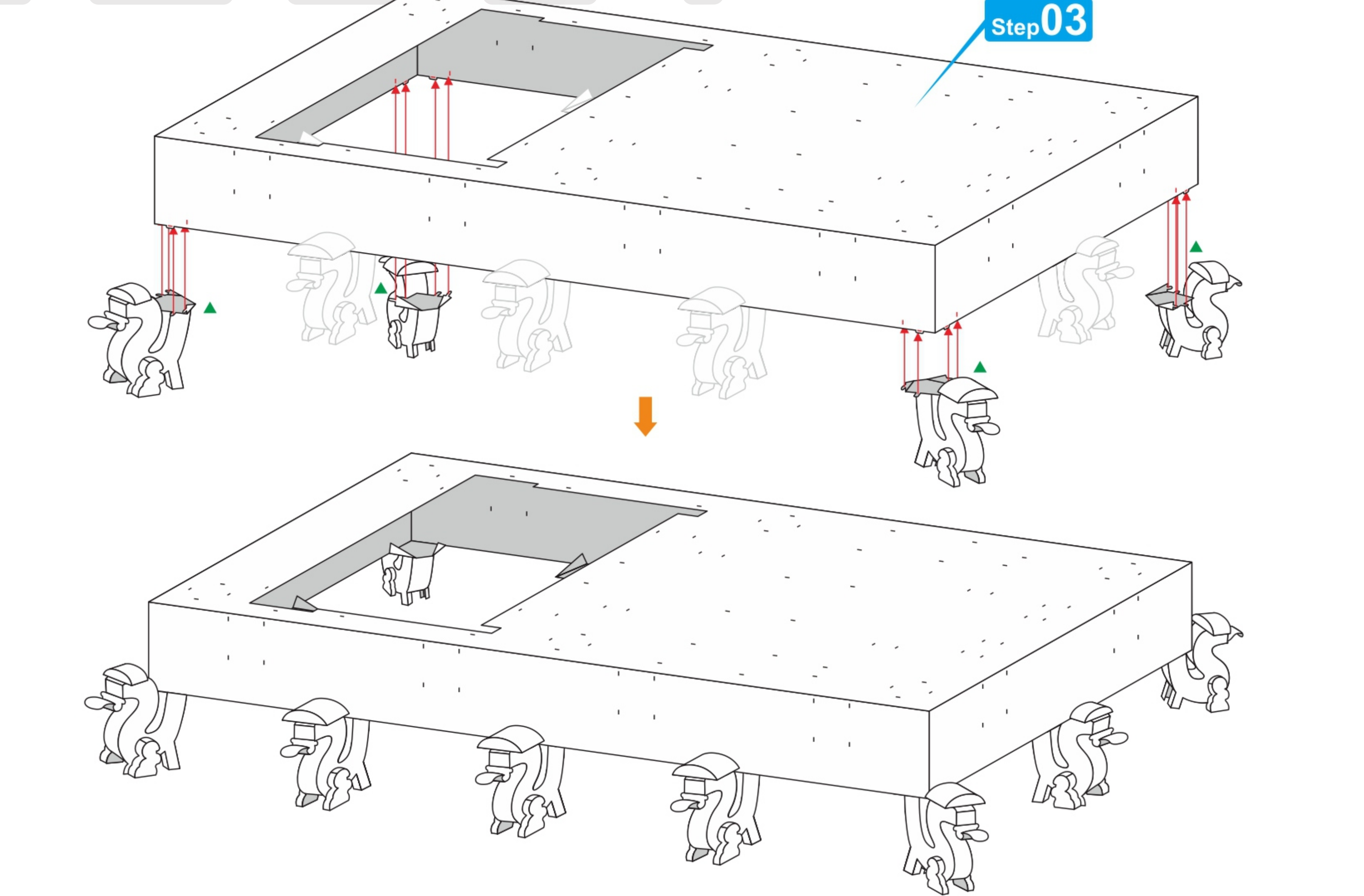
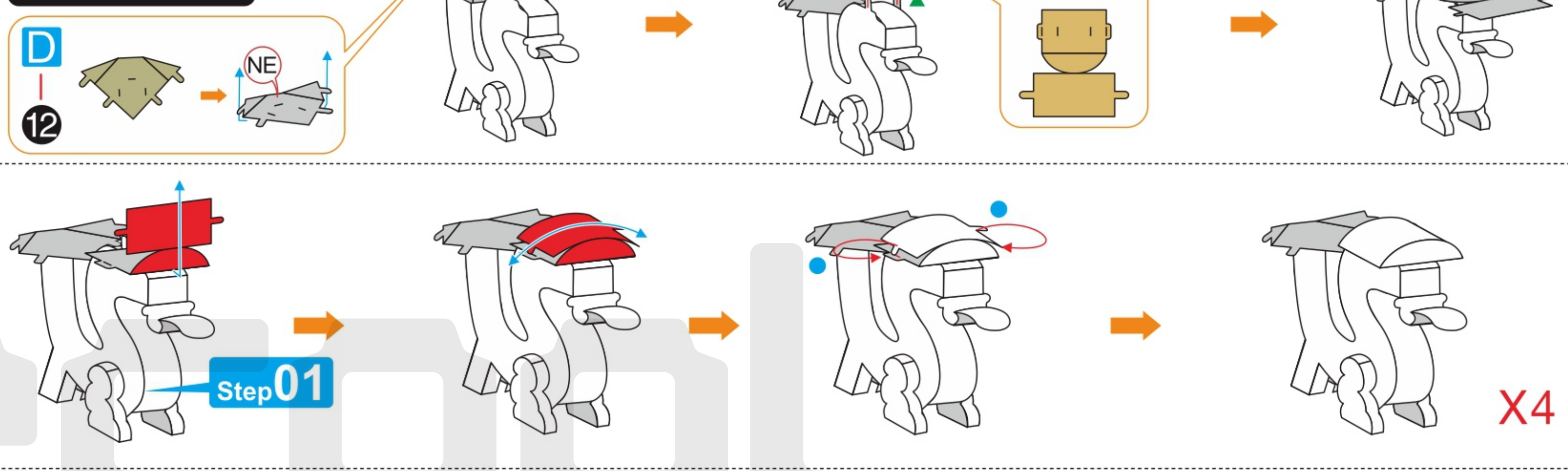

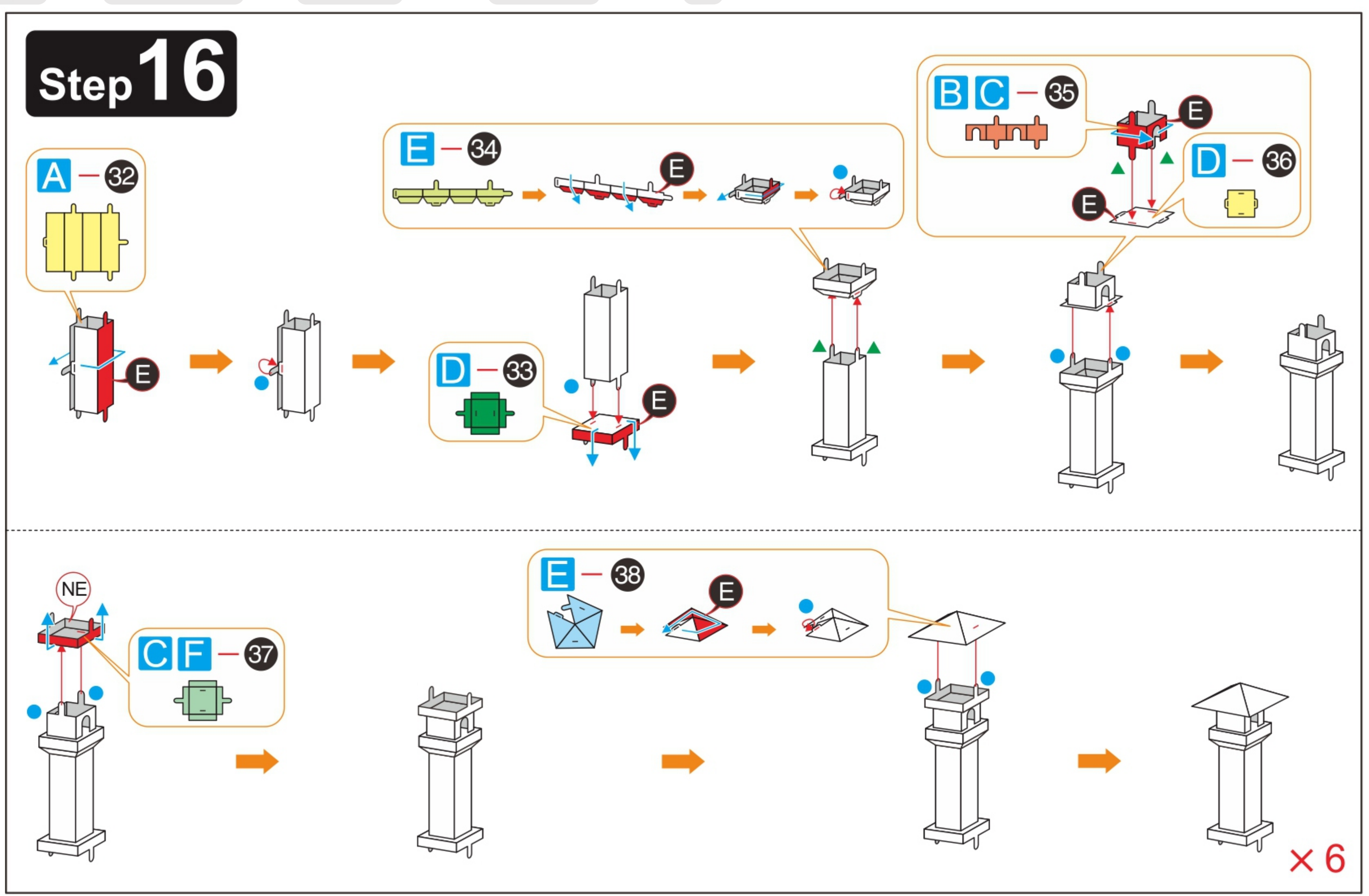
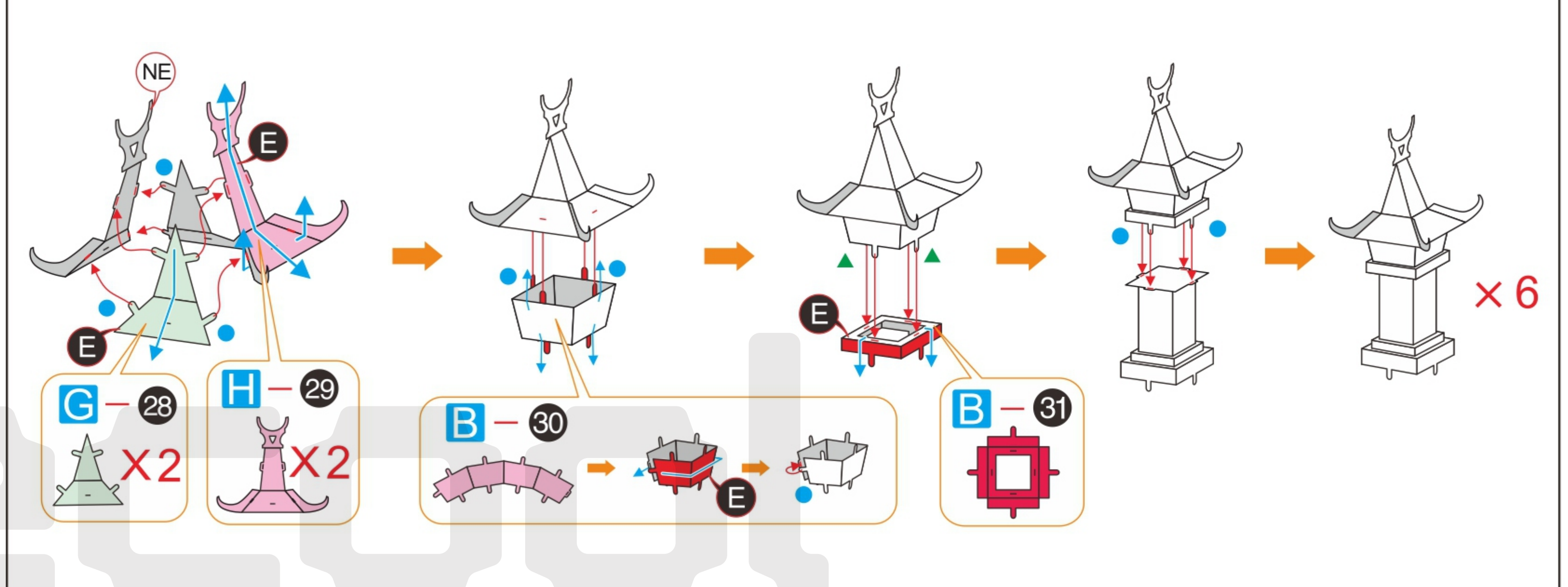
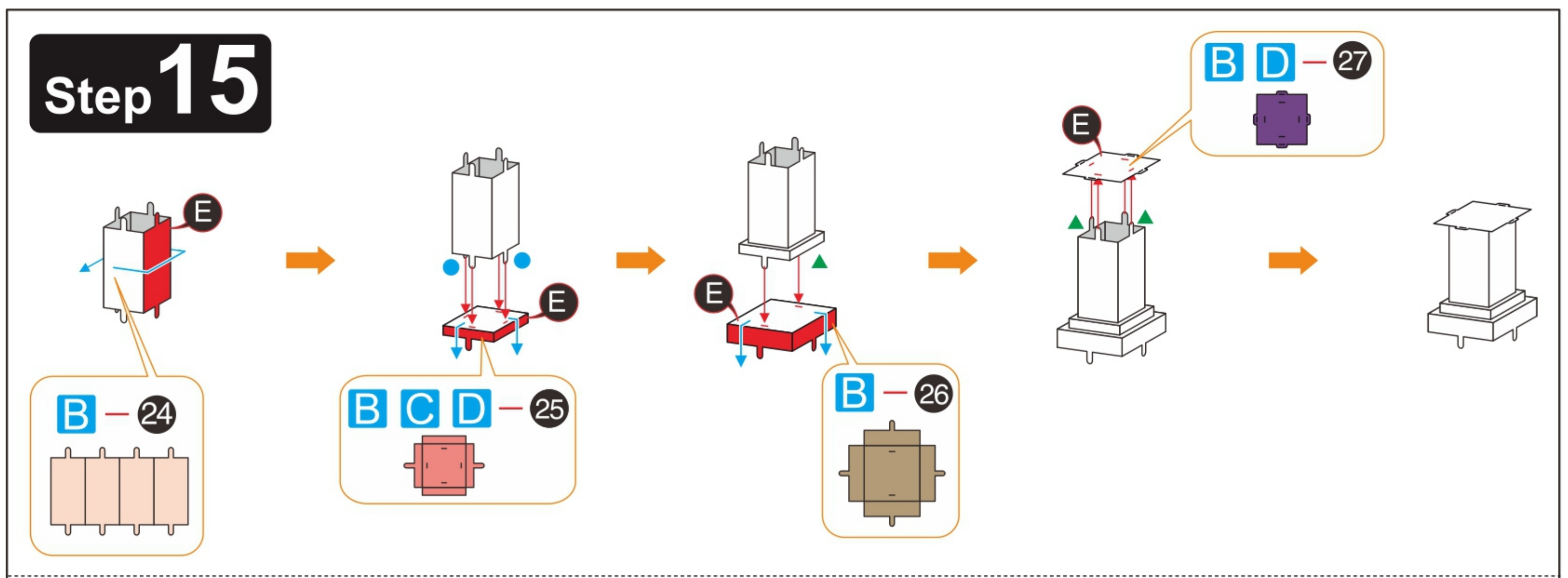
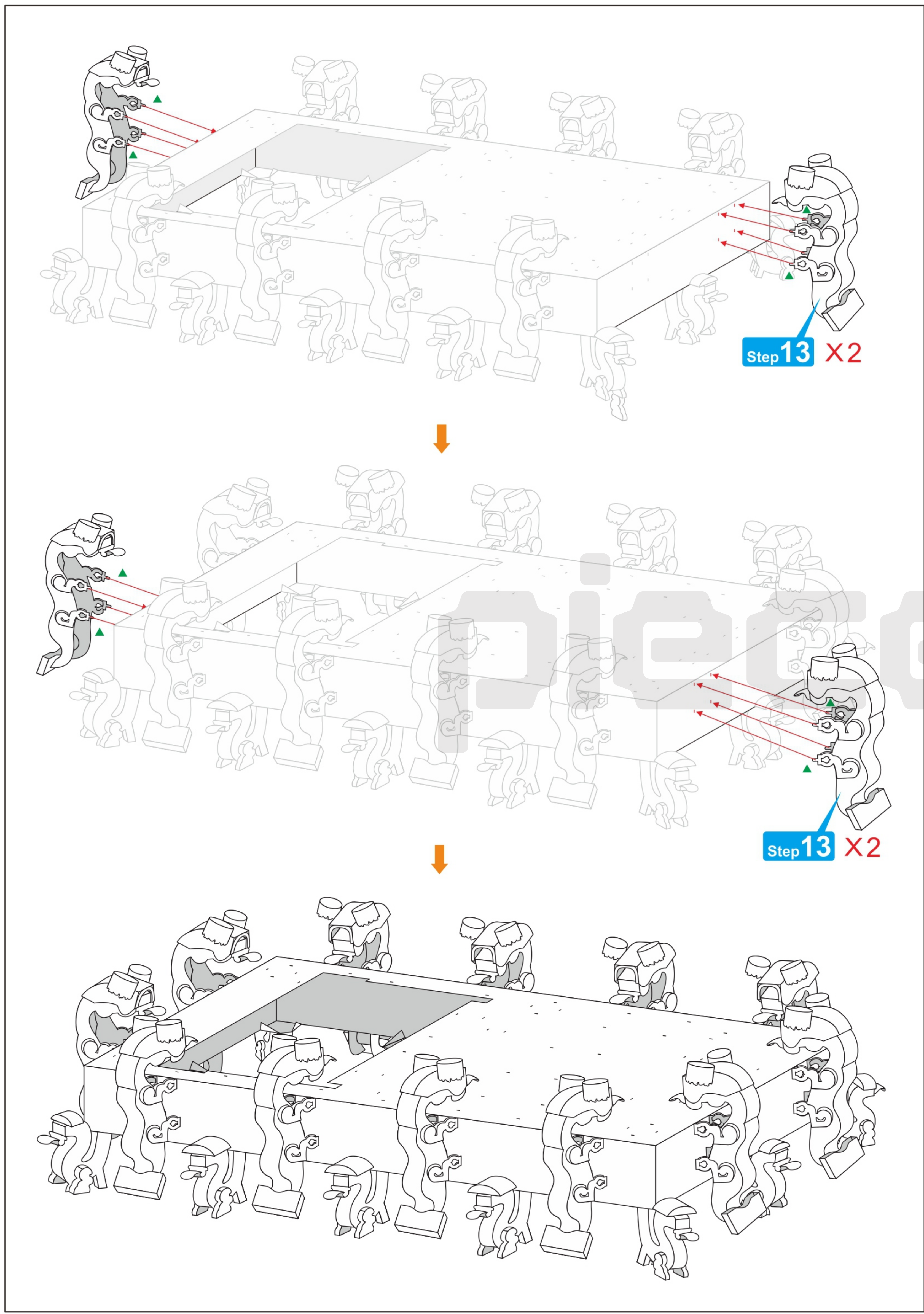
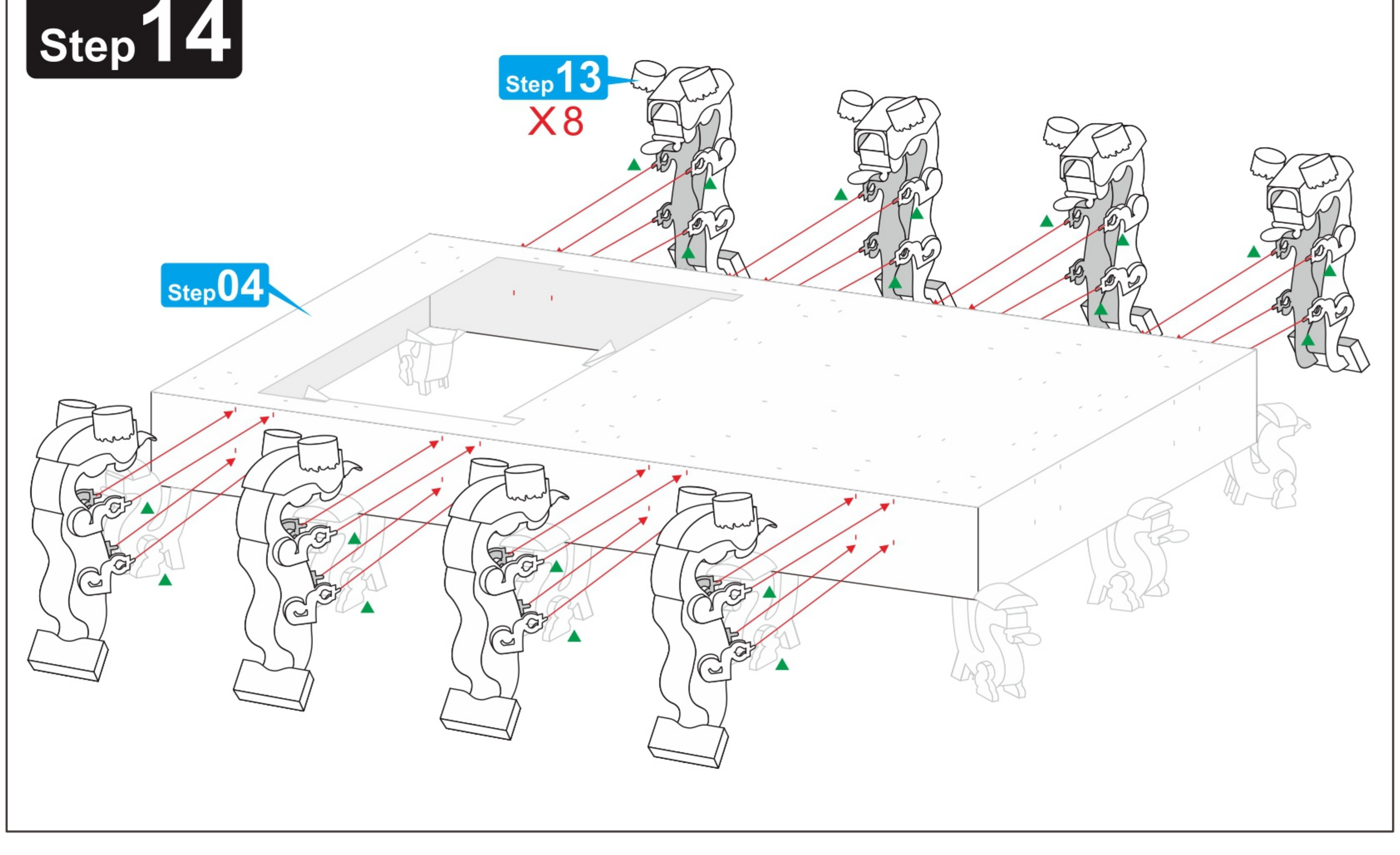
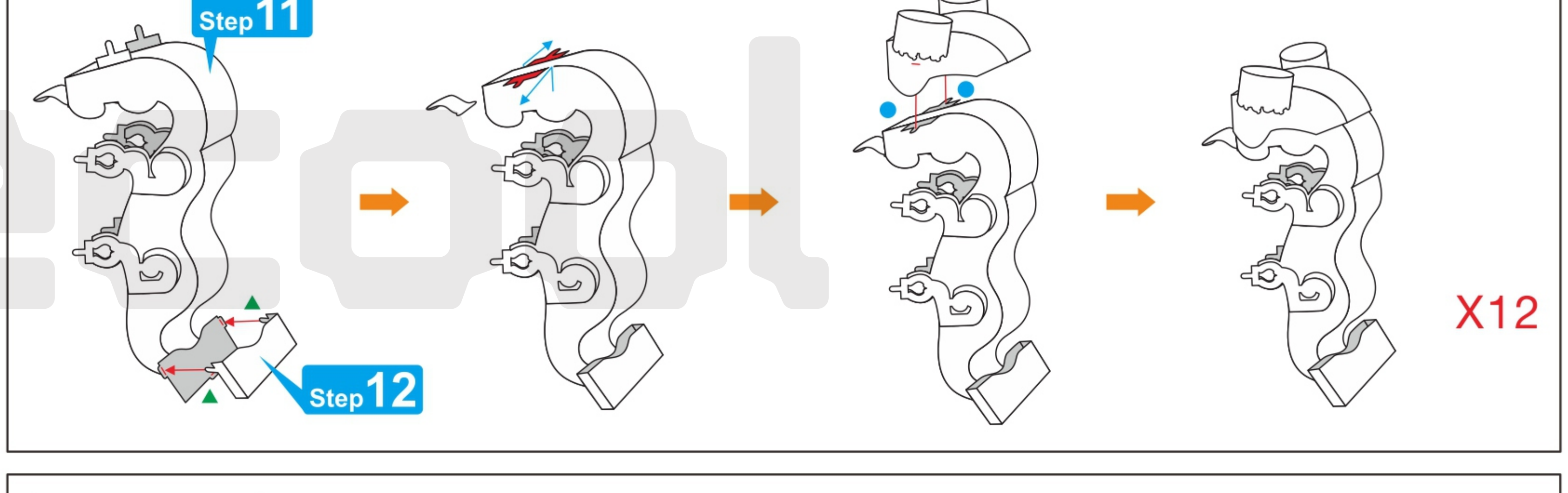
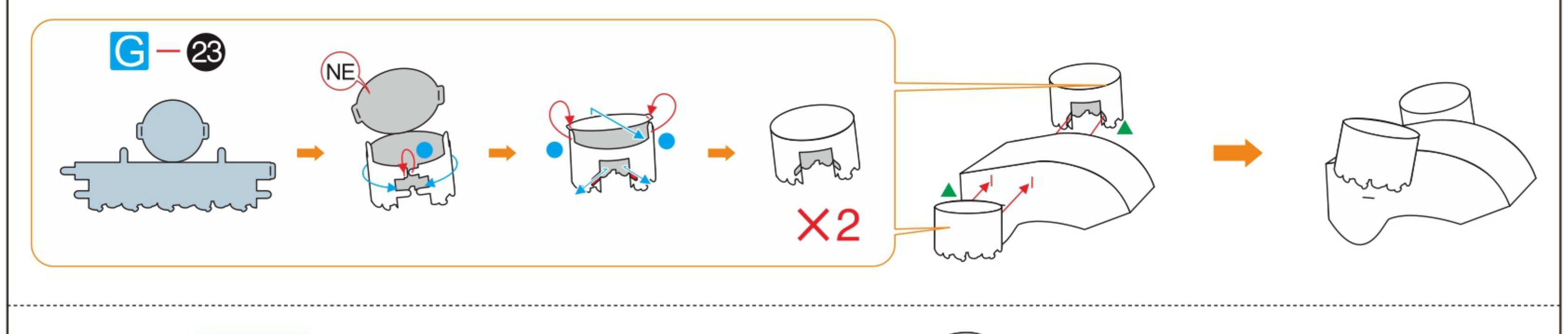
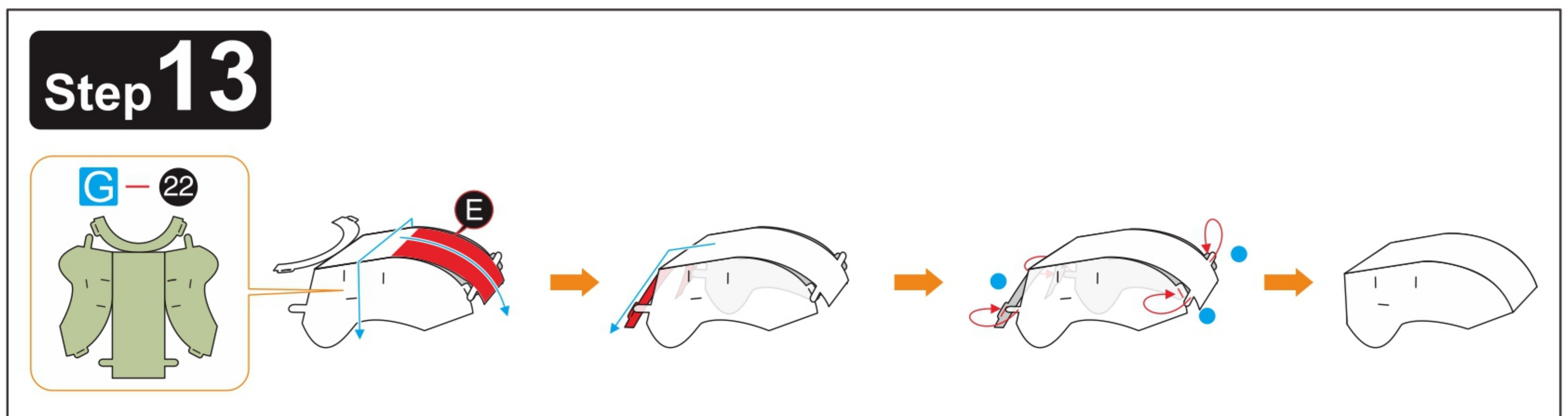
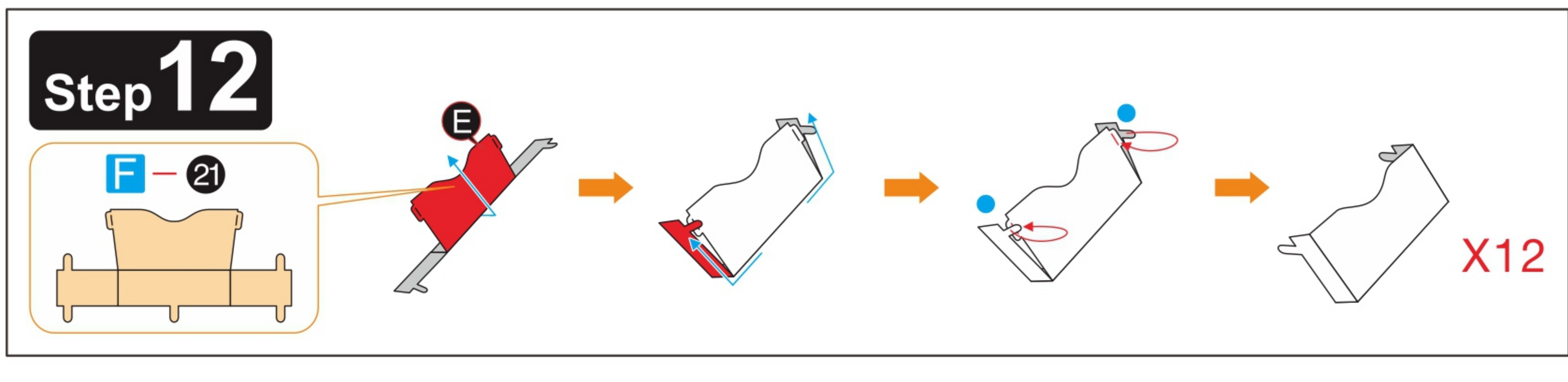
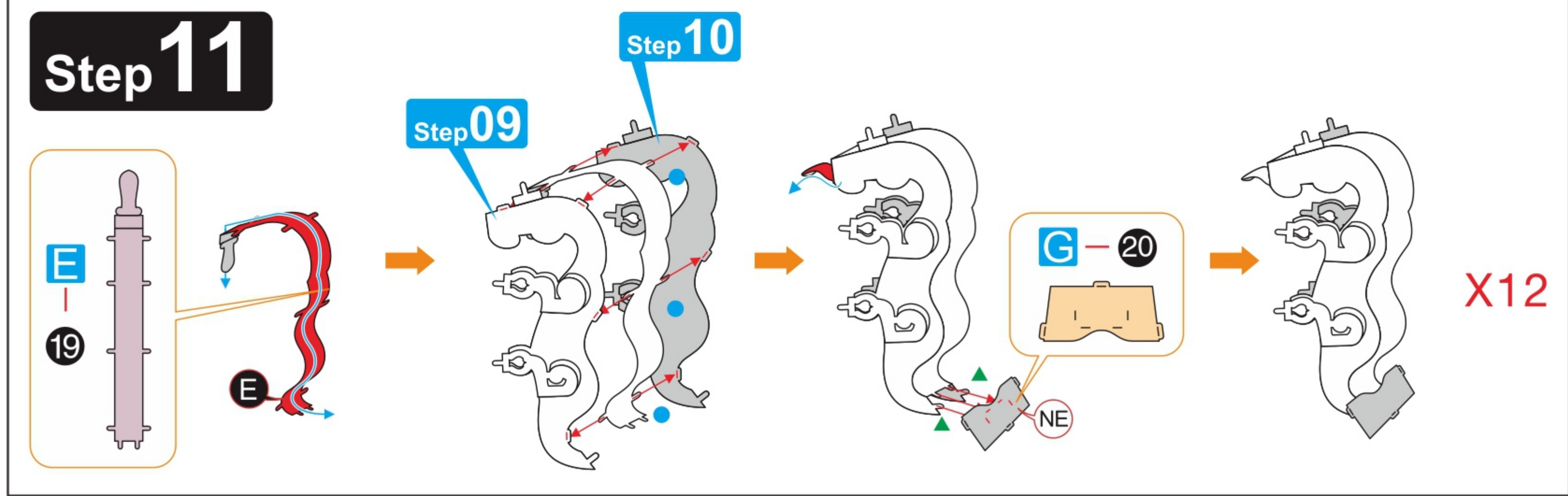
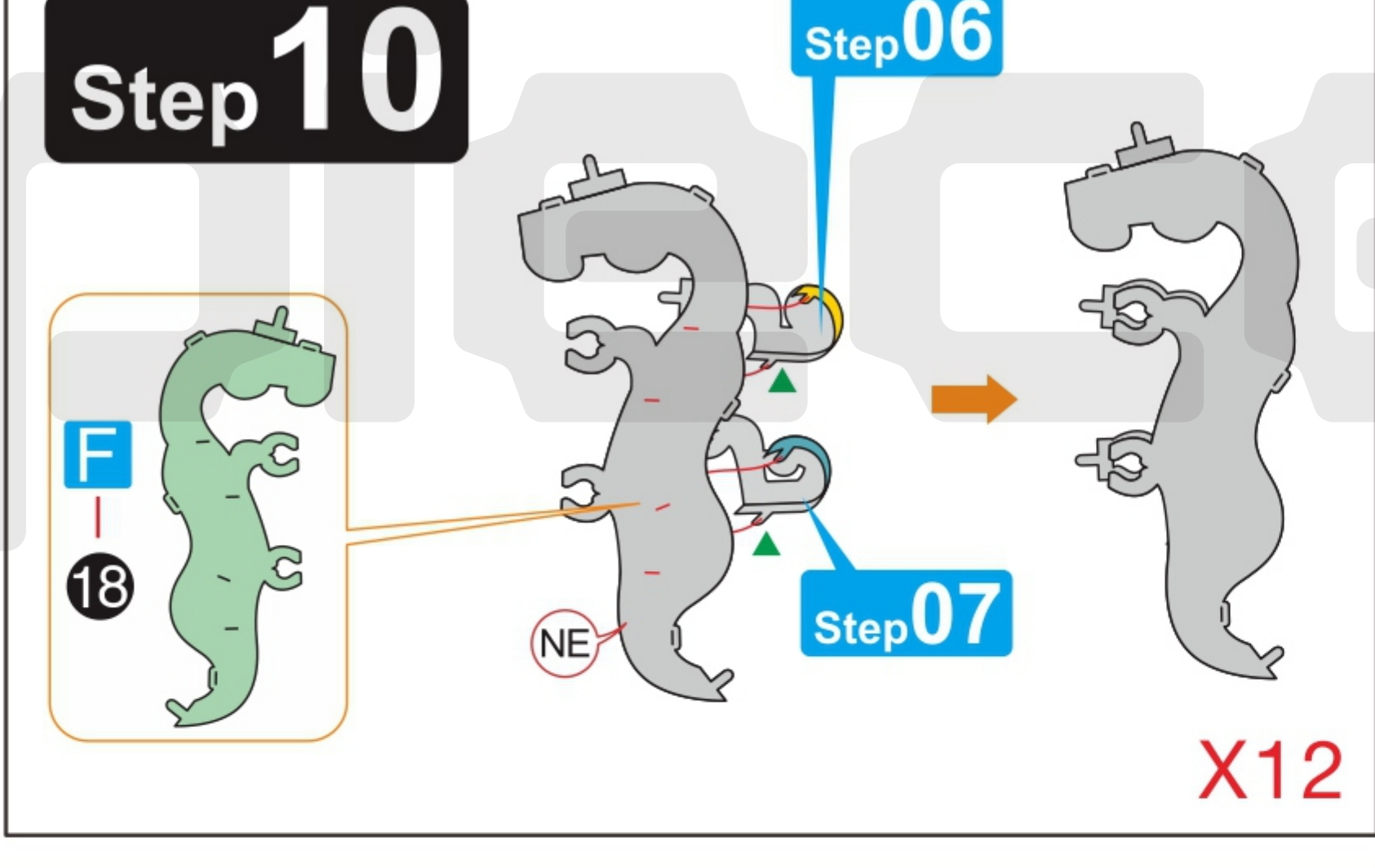
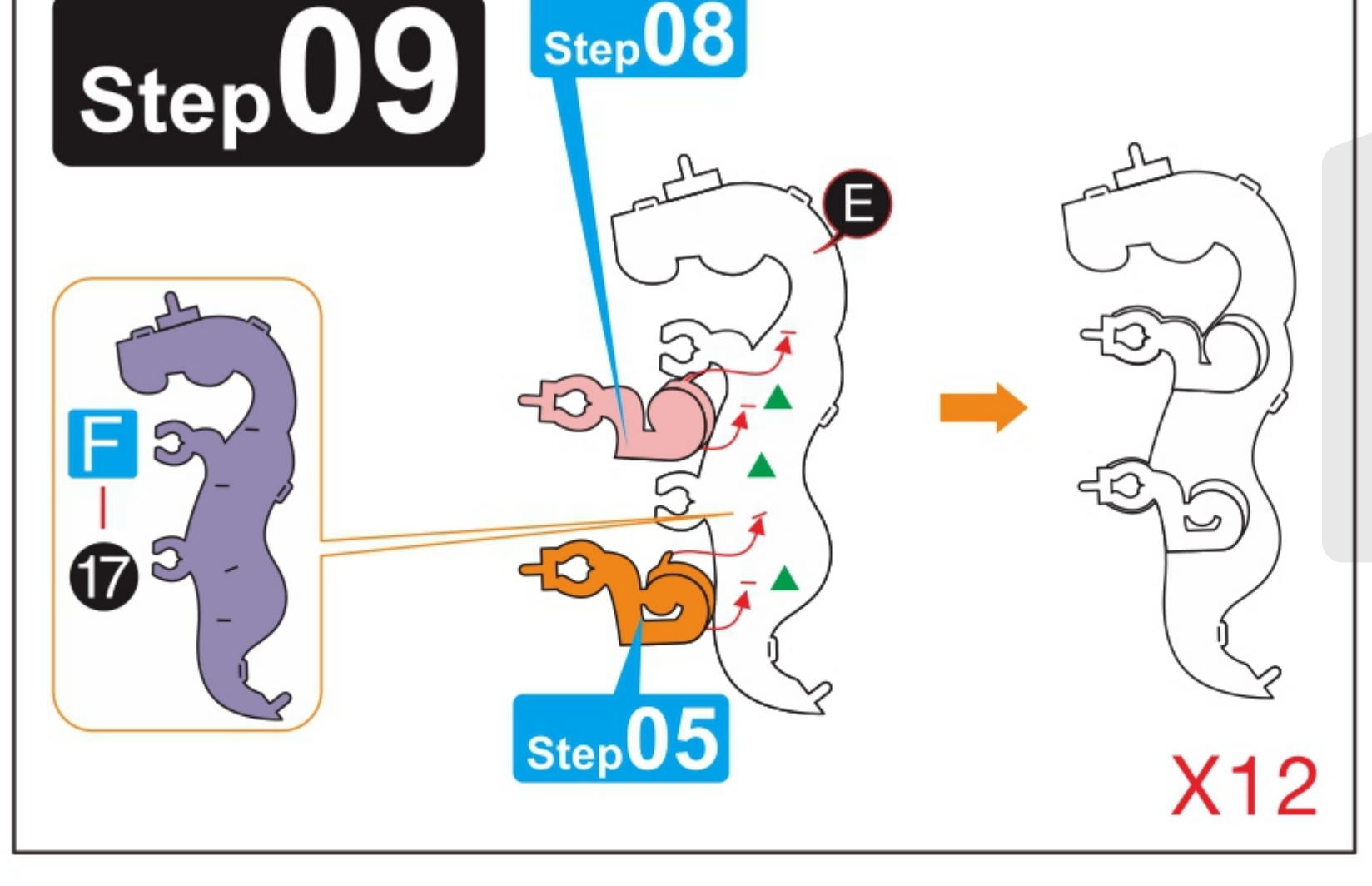
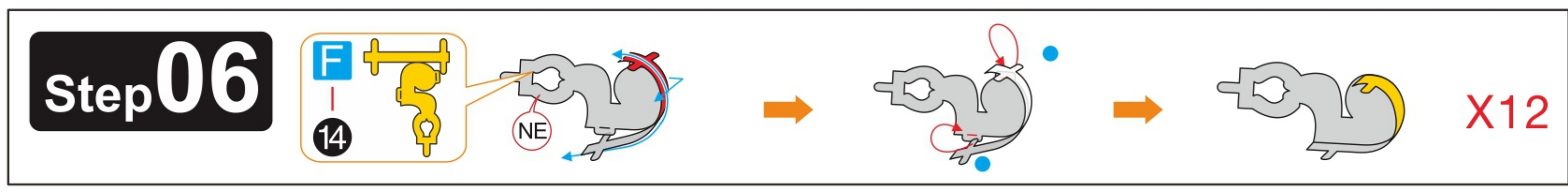
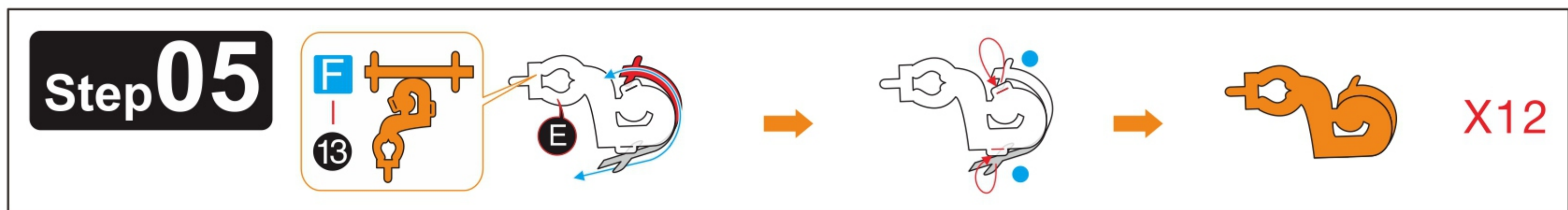

### Step 17

Step 17 assembly diagrams showing the construction of the base structure. It includes sub-steps for attaching parts D-40, A-39, D-41, and F-42 to the main frame.

### Step 18

Step 18 assembly diagrams showing the continuation of the base structure. It includes sub-steps for attaching parts D-43, D-45, and F-46.

### Step 19

Step 19 assembly diagrams showing the construction of the roof structure. It includes sub-steps for attaching parts D-48, E-47, F-50, H-51, and D-53.

### Step 20

Step 20 assembly diagrams showing the construction of the roof structure. It includes sub-steps for attaching parts H-55, D-54, F-56, D-57, and B-58.

### Step 21

Step 21 assembly diagrams showing the construction of the roof structure. It includes sub-steps for attaching parts B-59, D-61, B-62, and D-63.

### Step 22

Step 22 assembly diagrams showing the construction of the roof structure. It includes sub-steps for attaching parts A-64, H-65, D-66, and D-67.

9 10  
11 12

### Step 23

Step 23 assembly diagrams showing the construction of the roof structure. It includes sub-steps for attaching parts E-69 and H-68.

### Step 24

Step 24 assembly diagrams showing the construction of the roof structure. It includes sub-steps for attaching parts A-H-71, H-72, I-73, and C-74.

### Step 25

Step 25 assembly diagrams showing the construction of the roof structure. It includes sub-steps for attaching parts A-H-71, I-73, H-72, and B-75.

### Step 26

Step 26 assembly diagrams showing the construction of the roof structure. It includes sub-steps for attaching parts E-76 and B-77.

### Step 27

Step 27 assembly diagrams showing the construction of the roof structure. It includes sub-steps for attaching parts B-79, A-78, and I-80.

### Step 28

Step 28 assembly diagrams showing the construction of the roof structure. It includes sub-steps for attaching parts D-81, C-83, and D-84.

### Step 29

Step 29 assembly diagrams showing the construction of the roof structure. It includes sub-steps for attaching parts B-85, H-86, and Step 27.

### Step 30

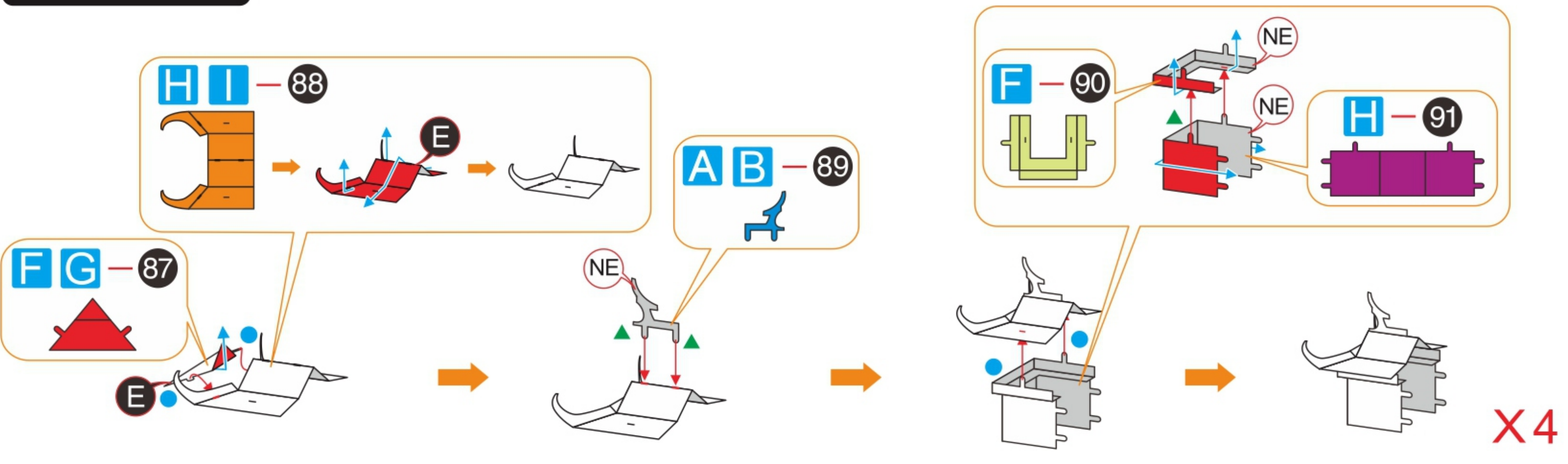

### Step 31

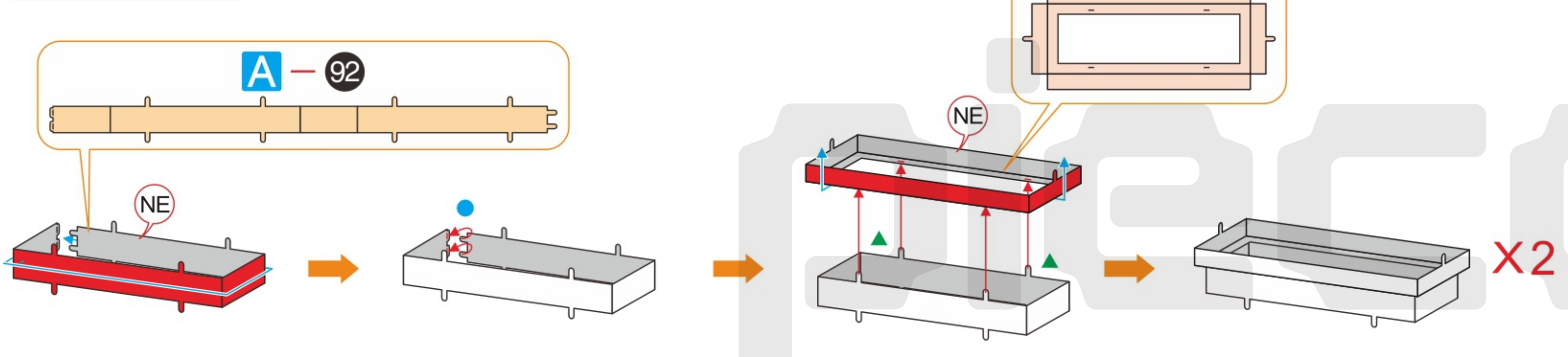

### Step 32

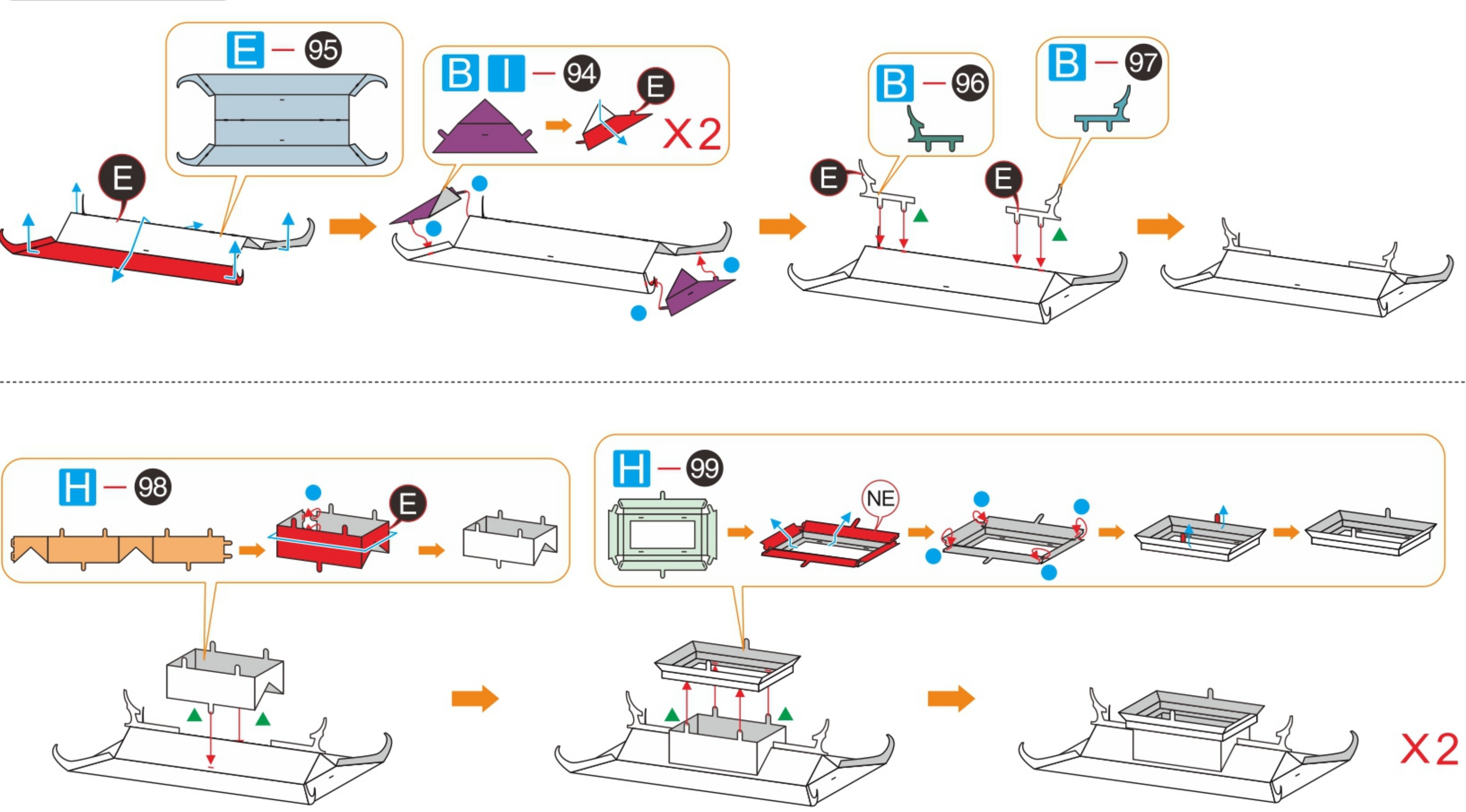

### Step 33

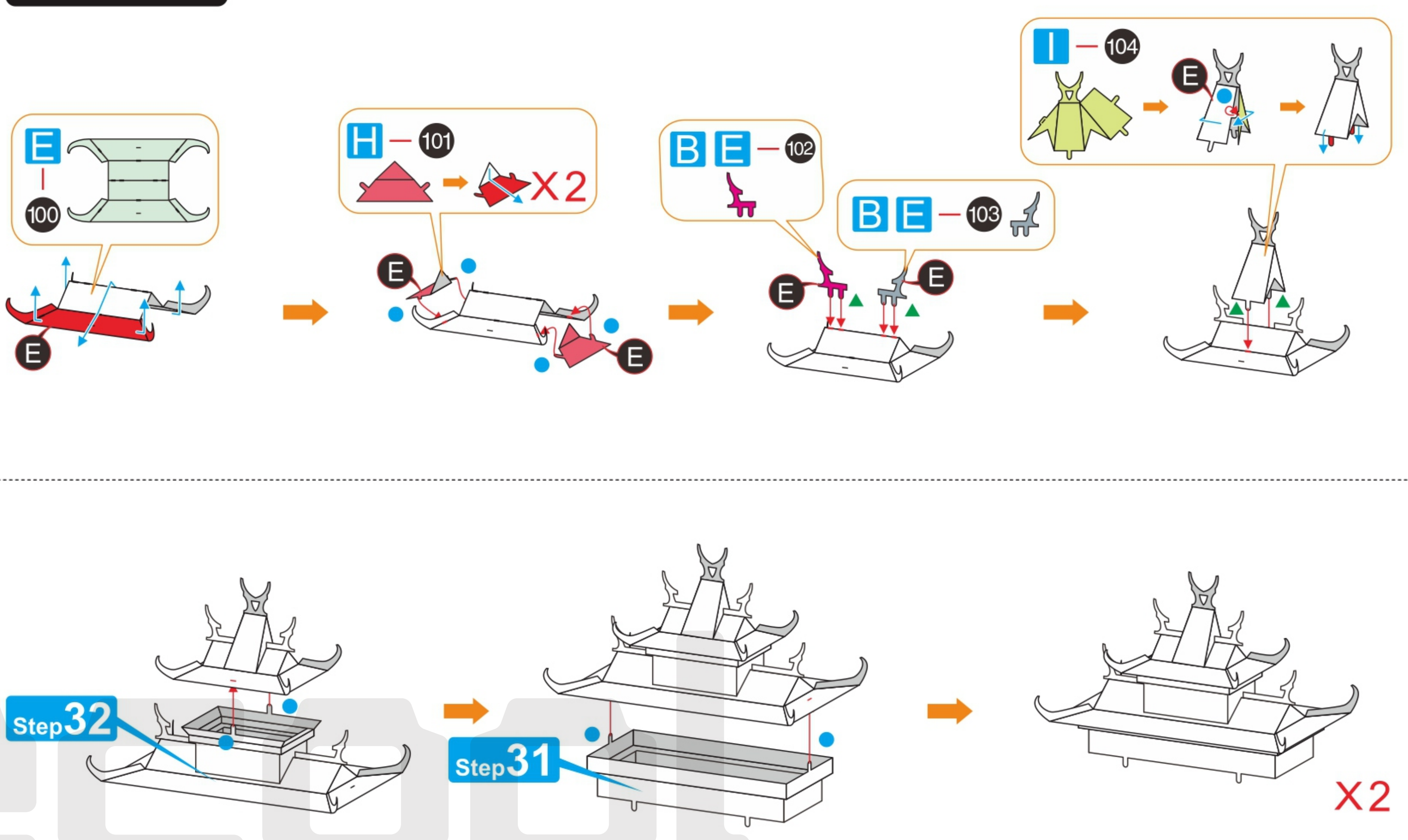

### Step 34

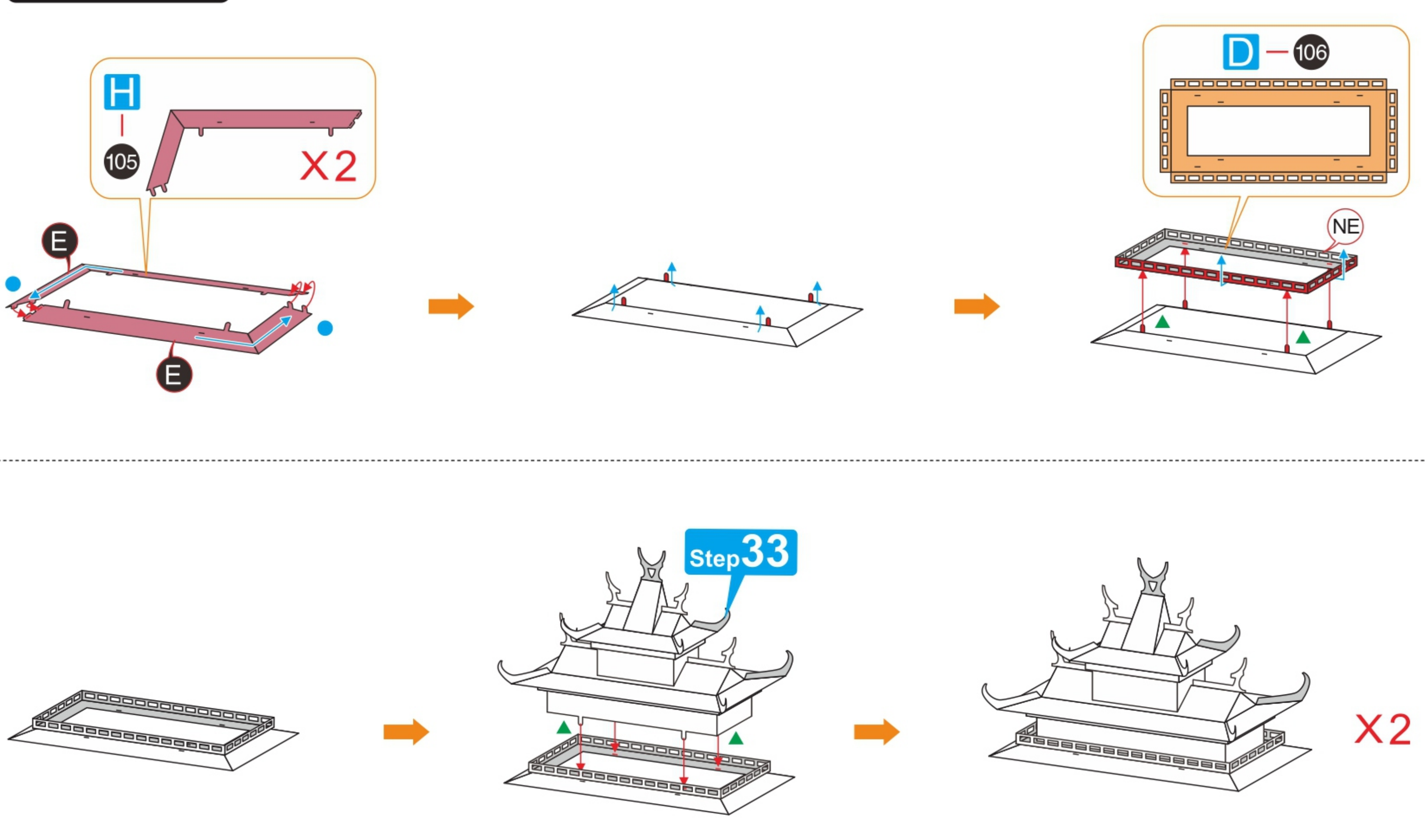

### Step 35

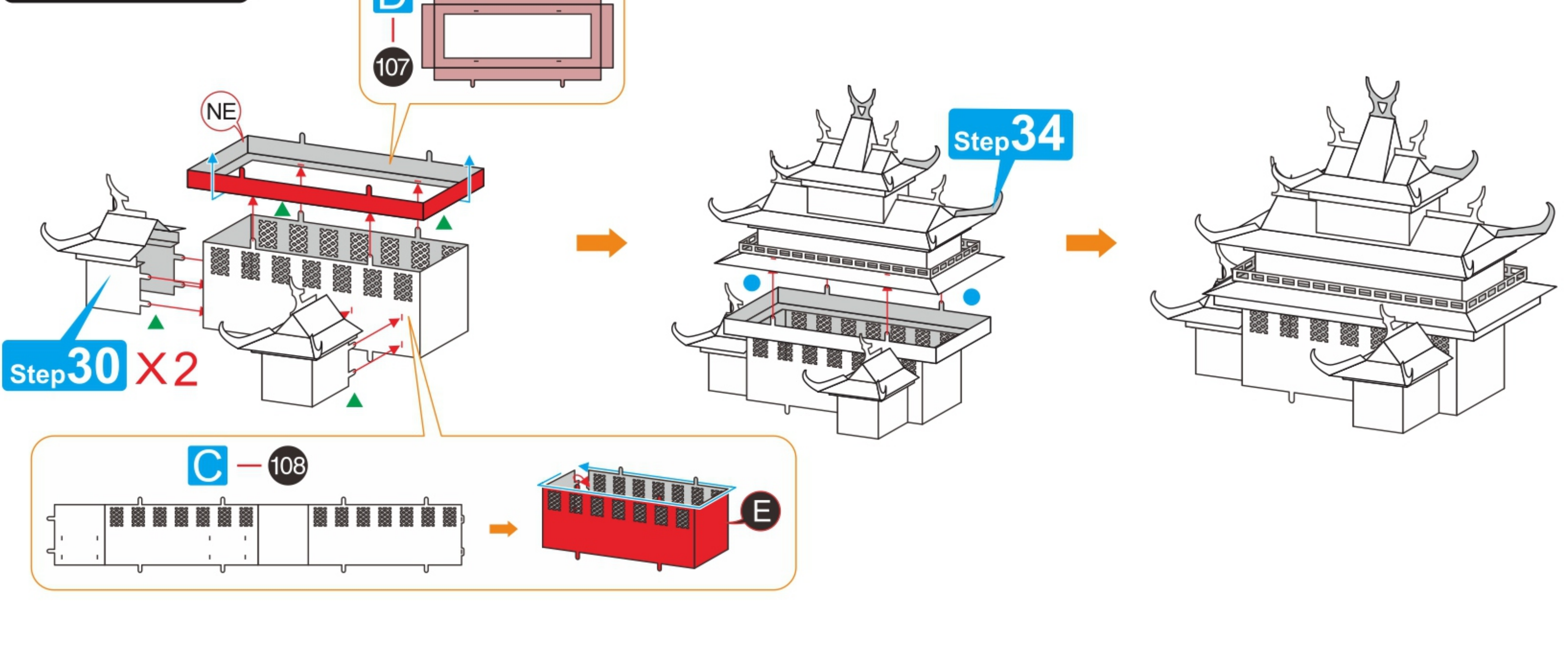

### Step 36

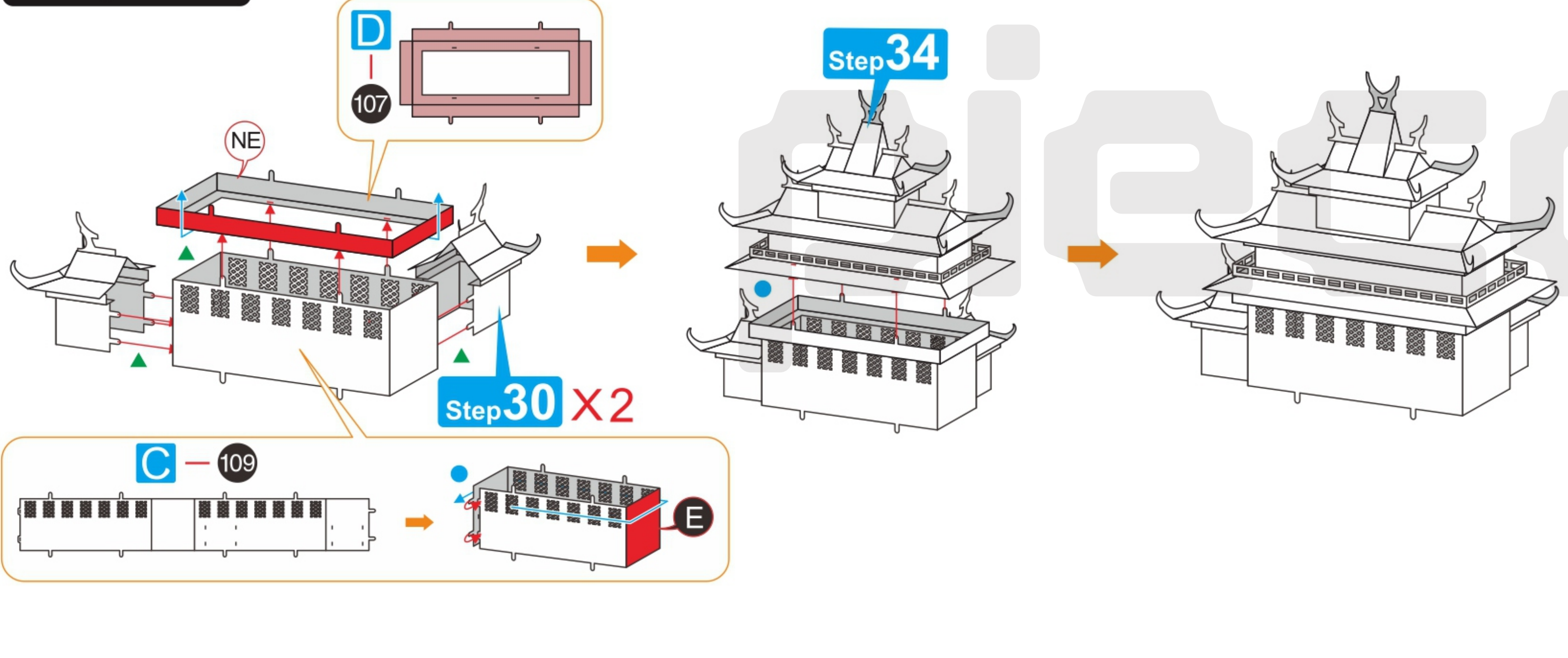

### Step 37

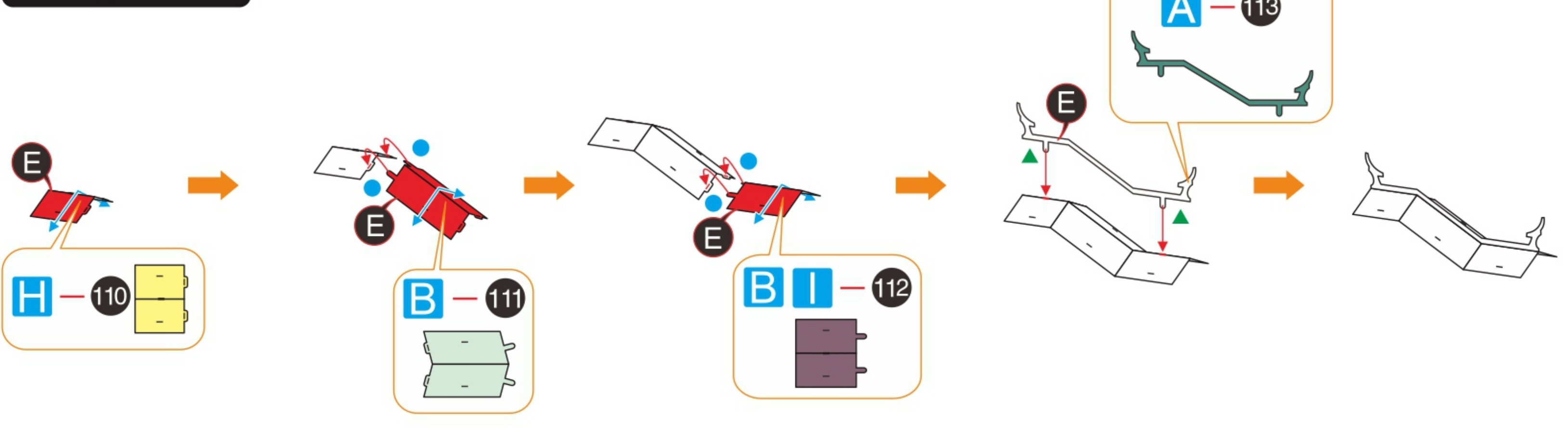

### Step 38

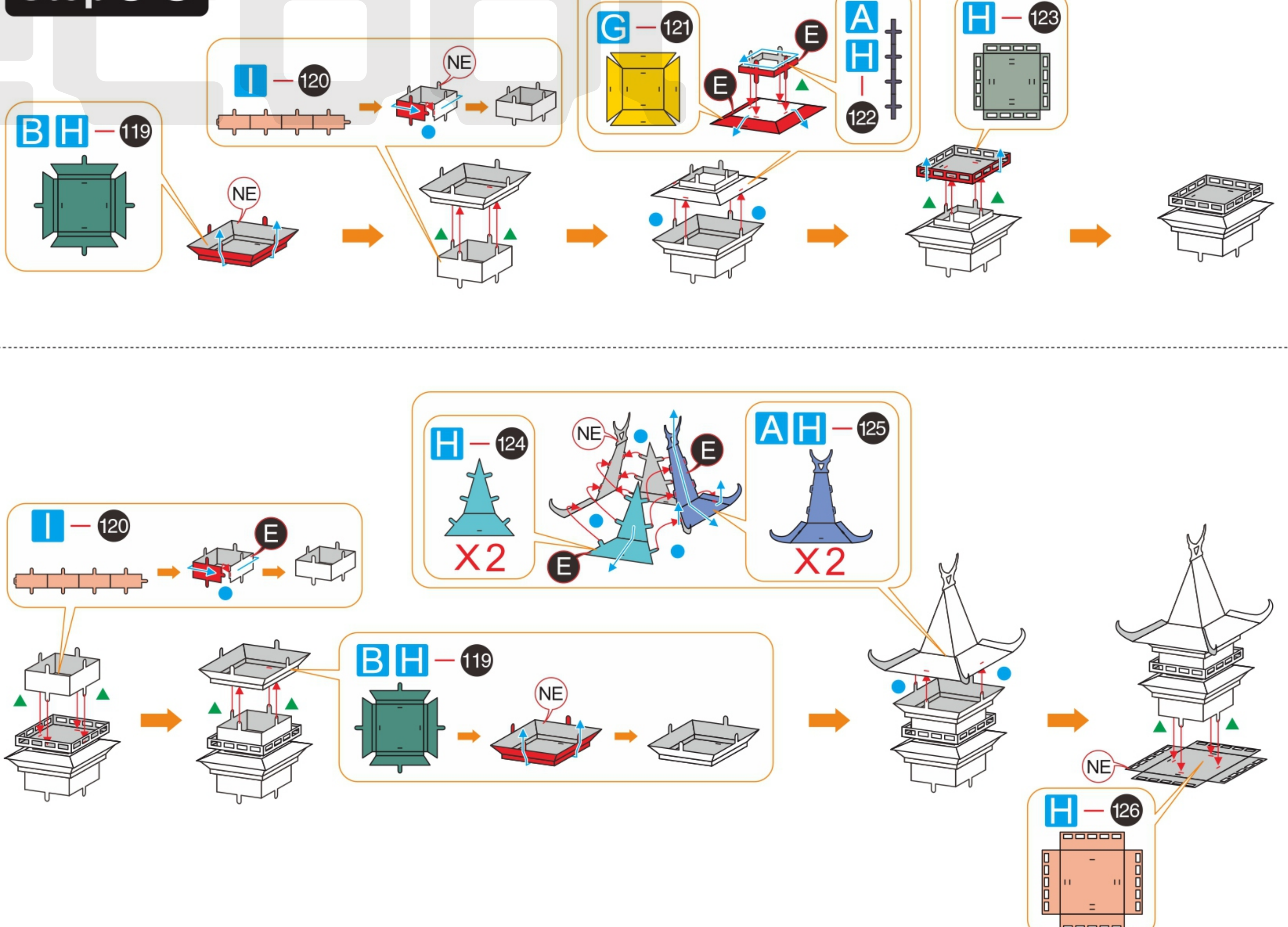

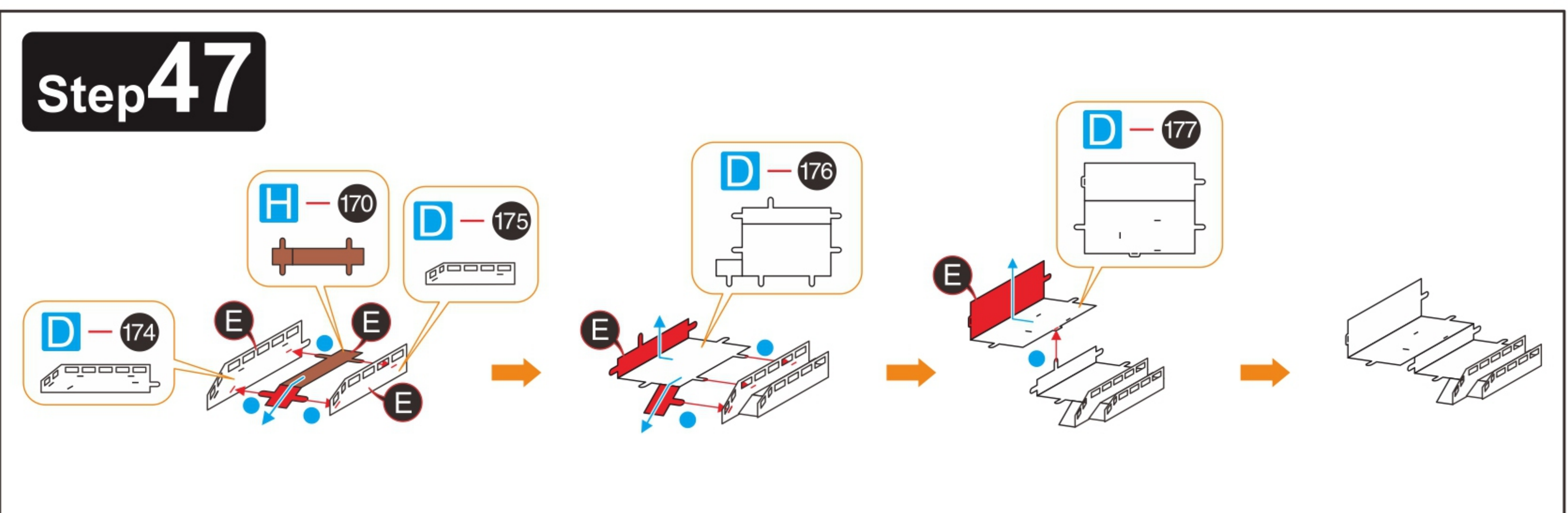
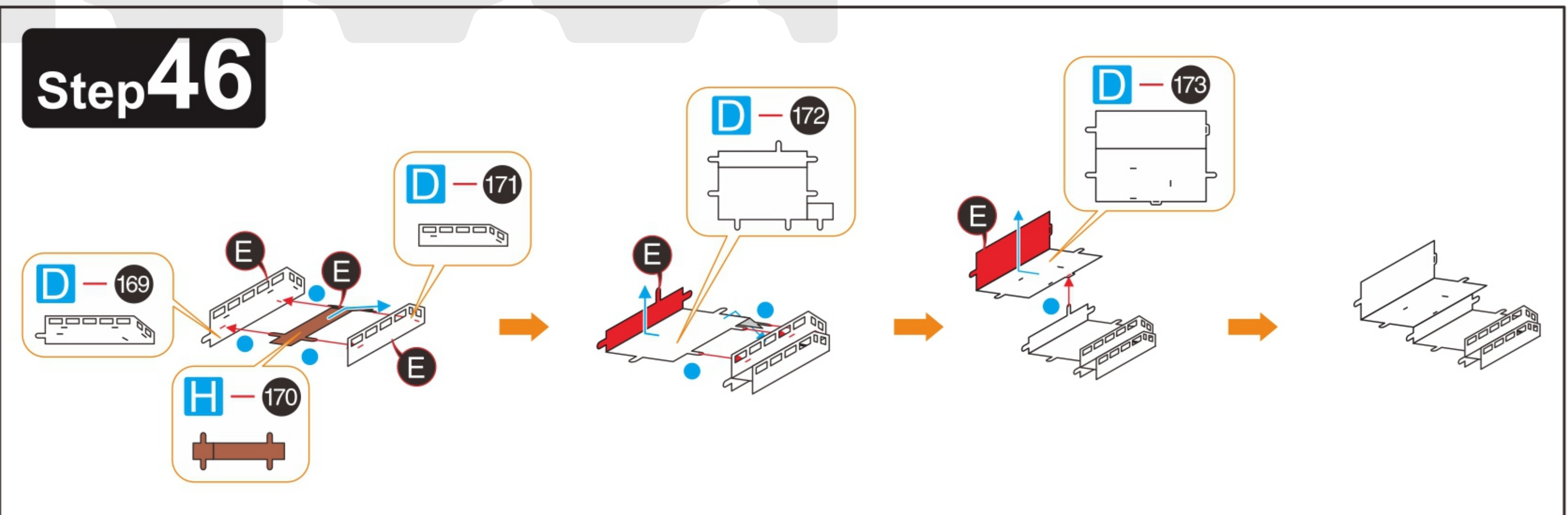
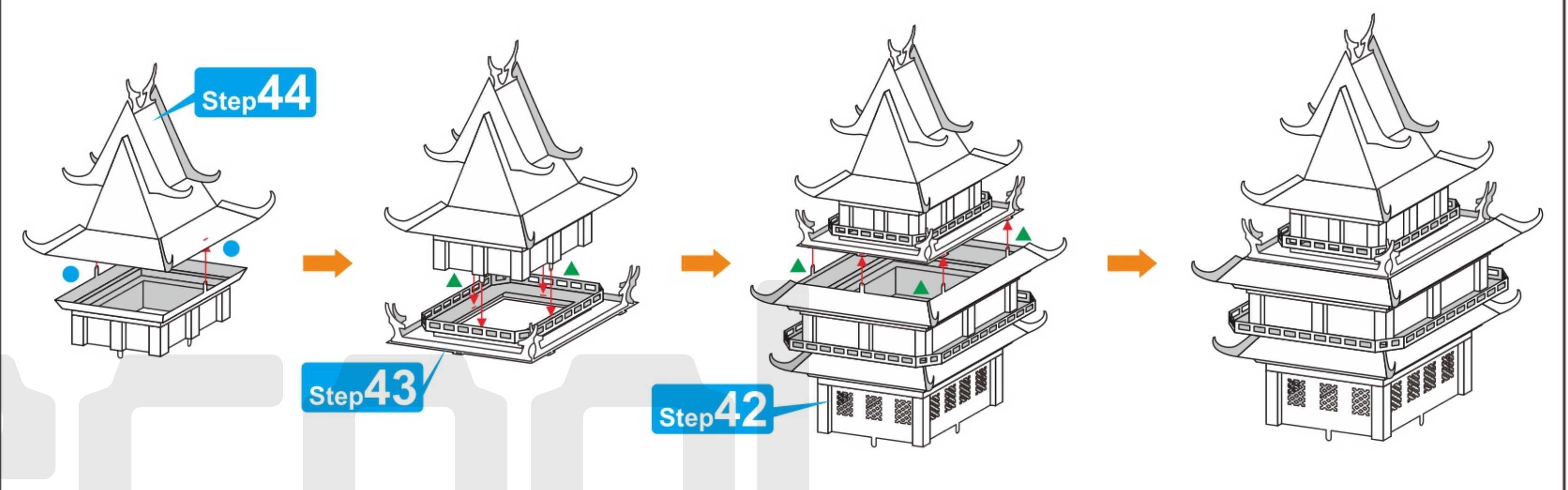
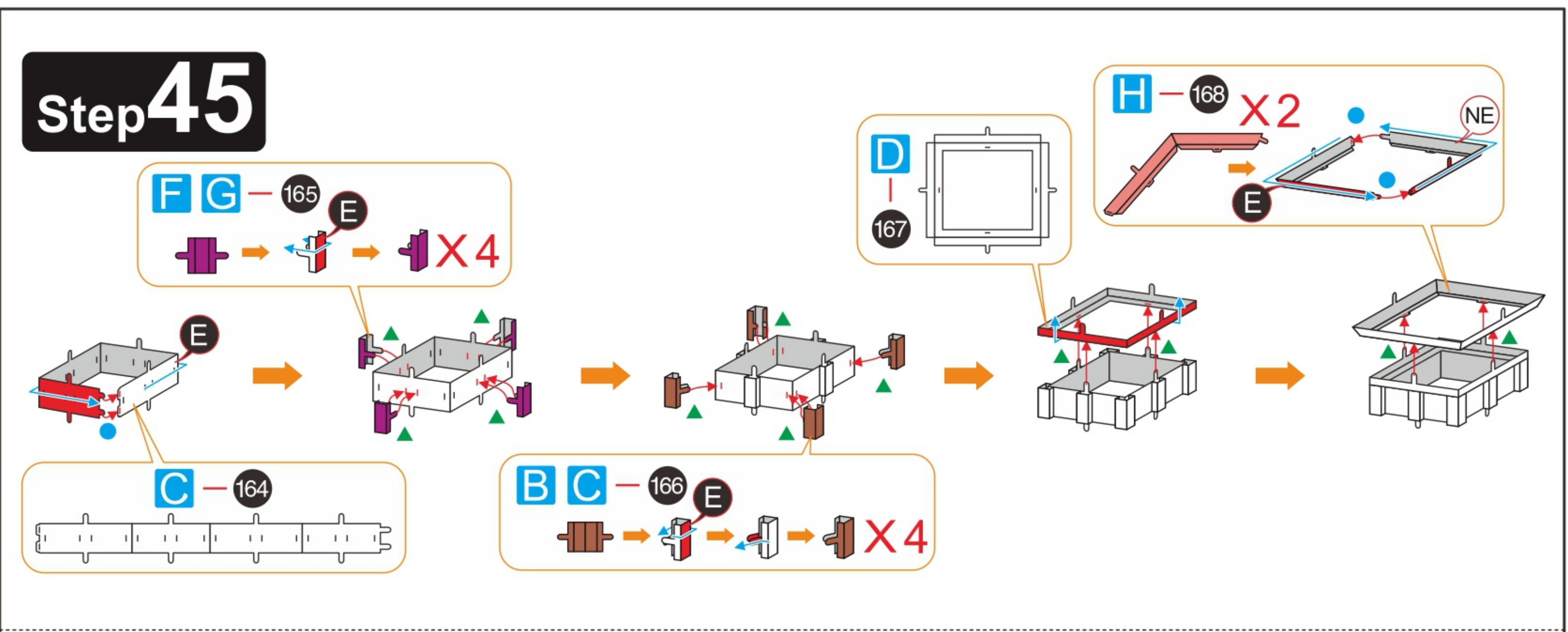
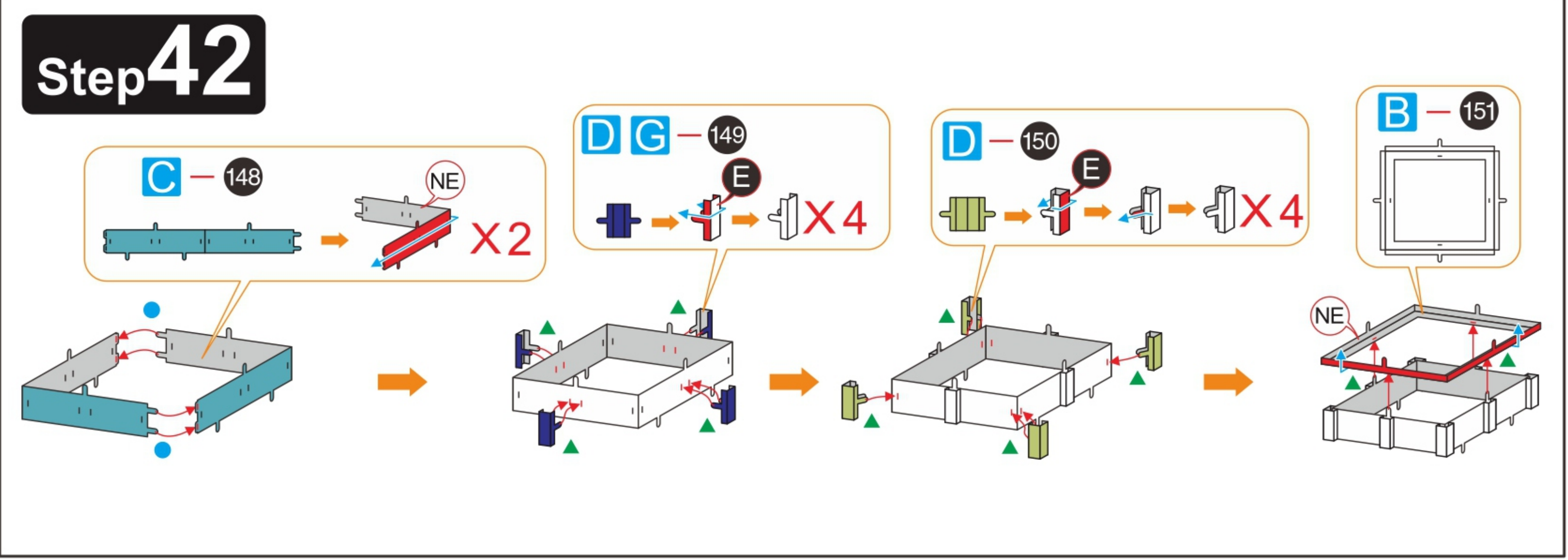
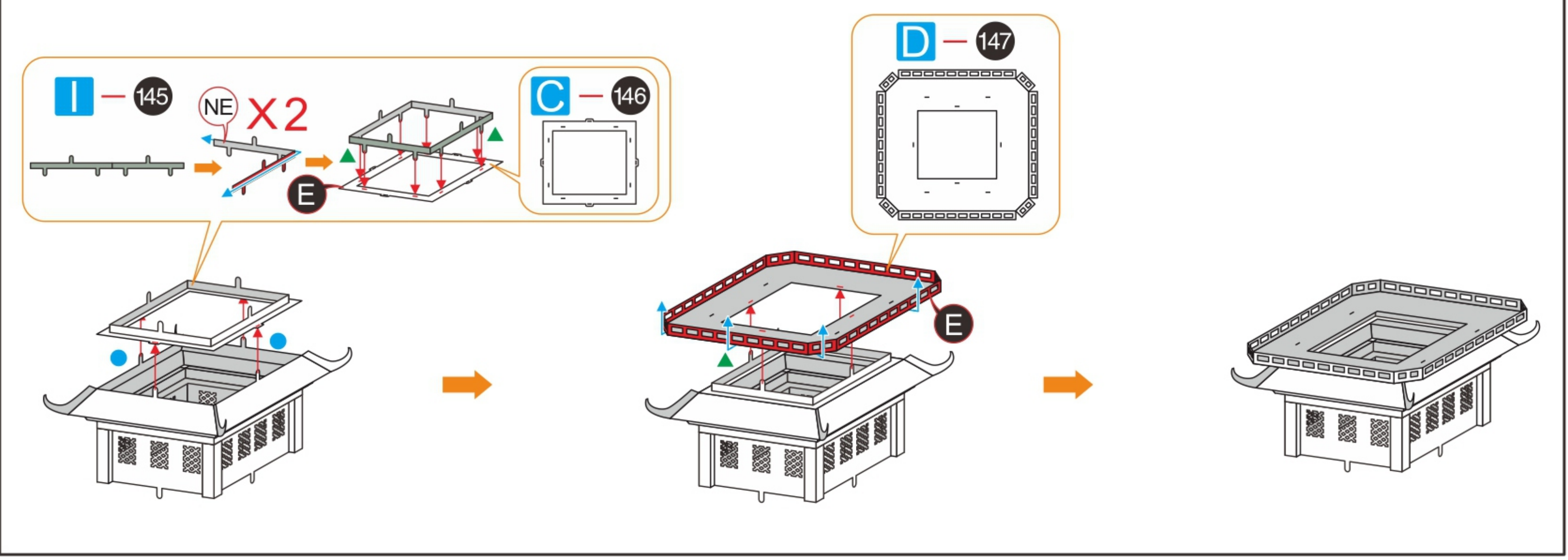
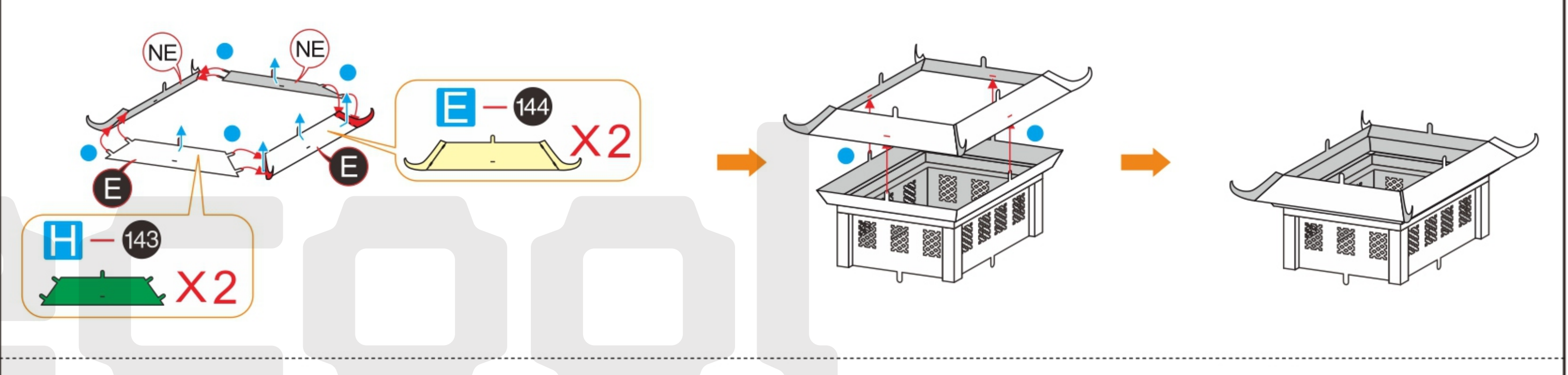
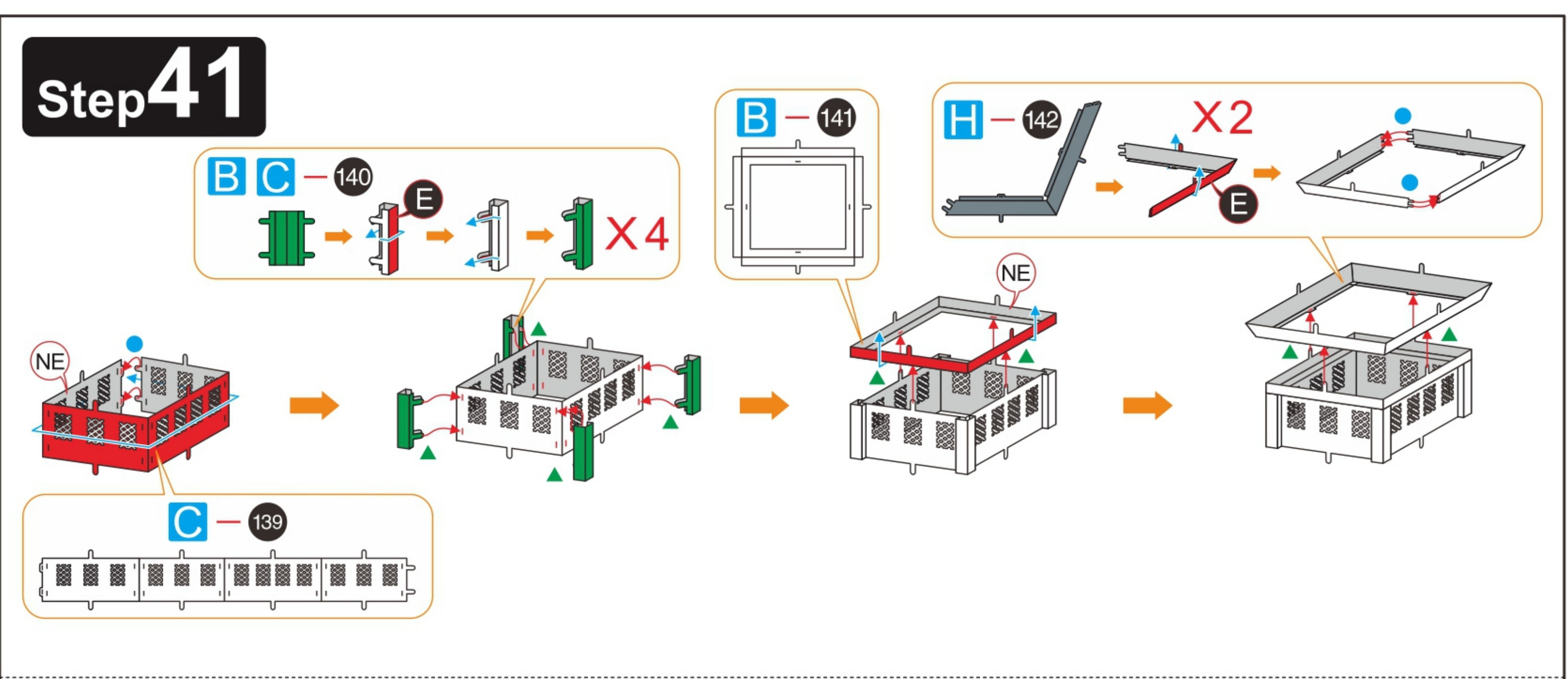
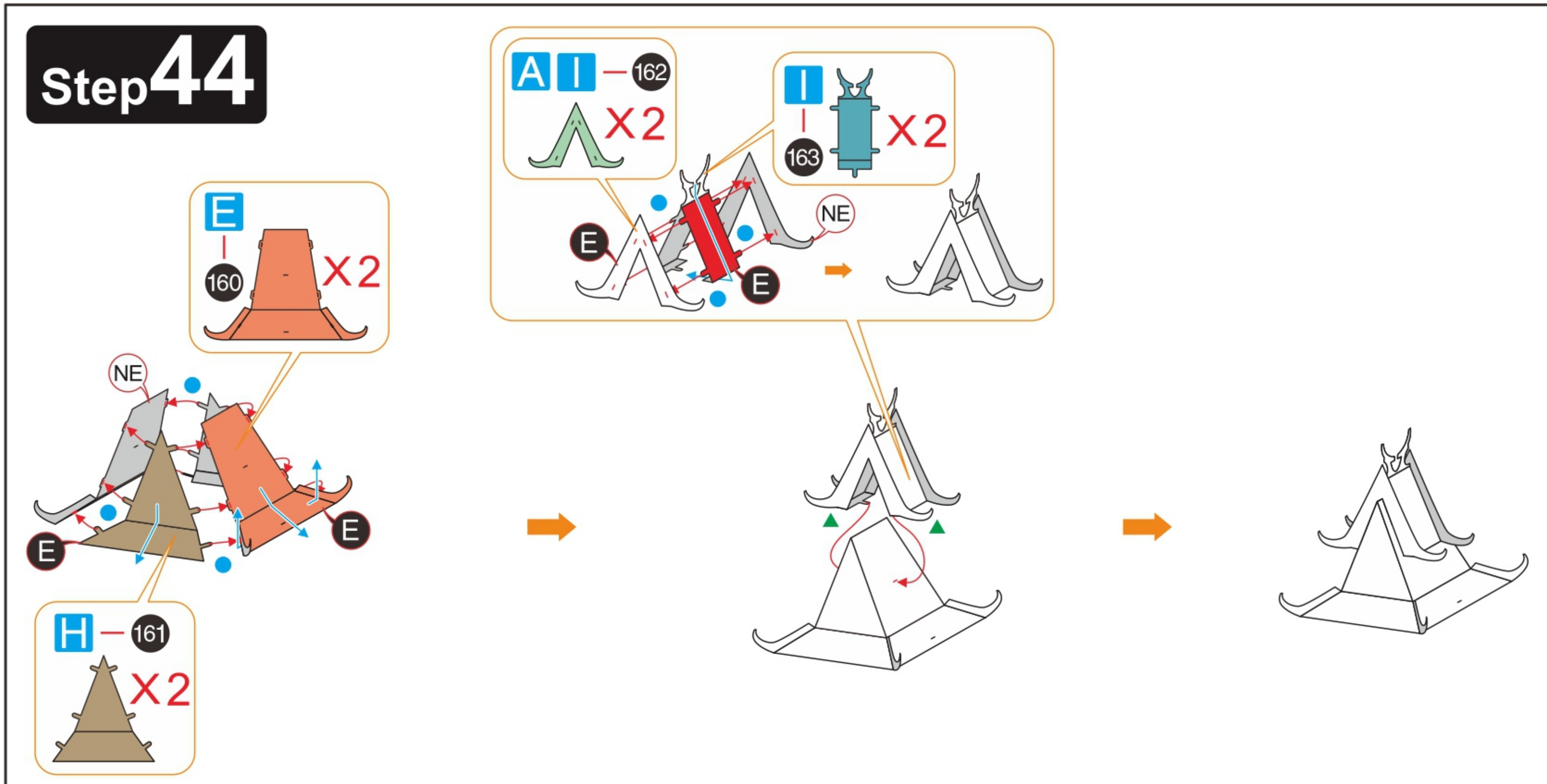
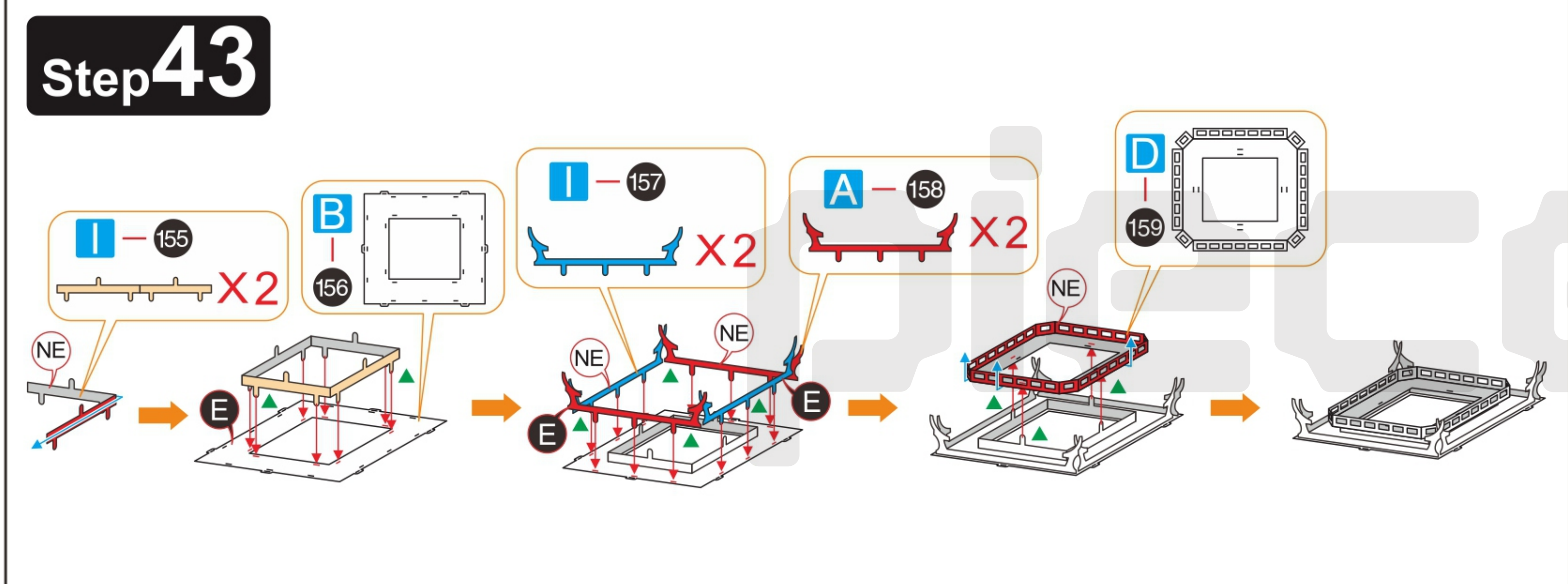
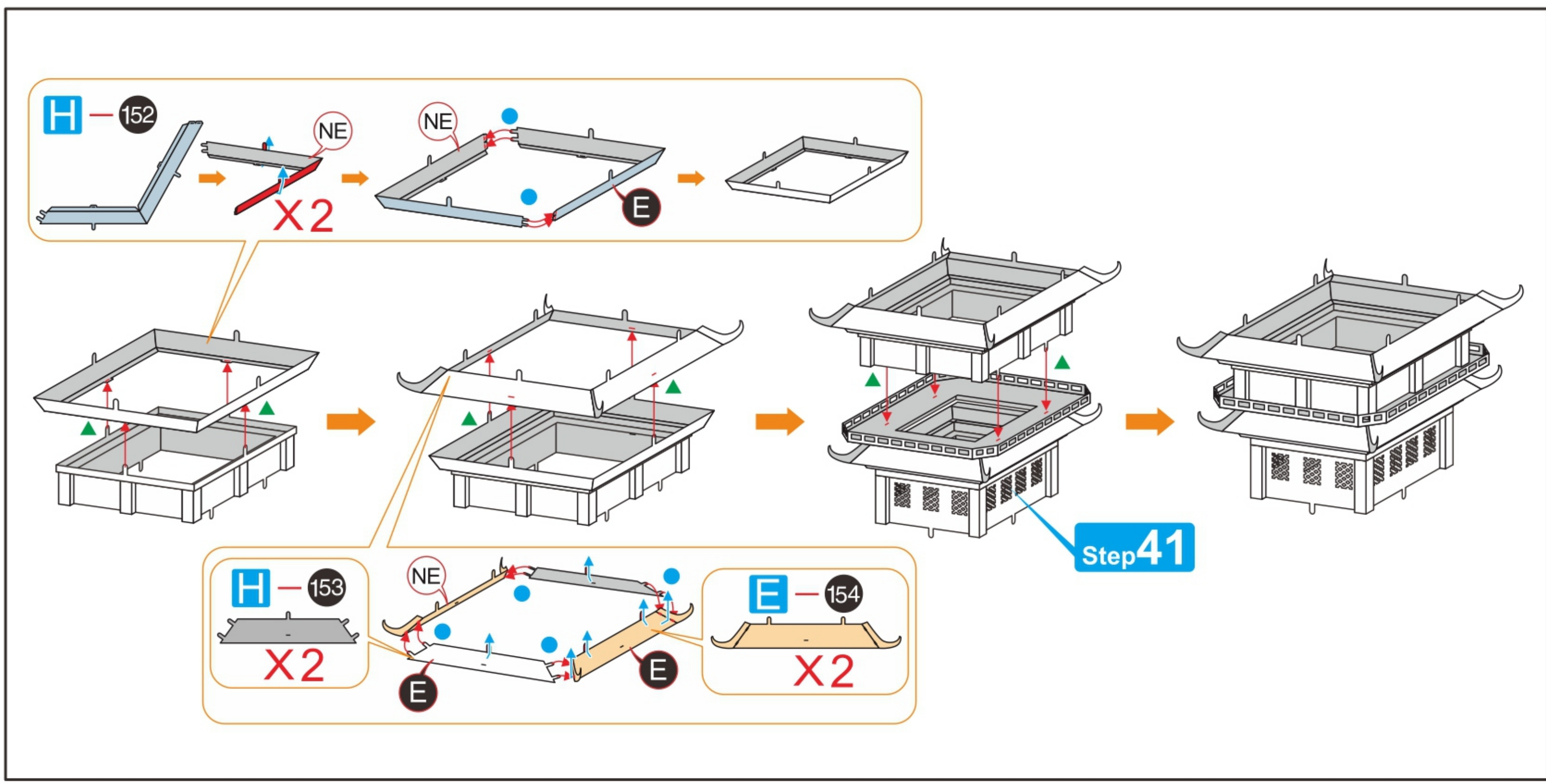
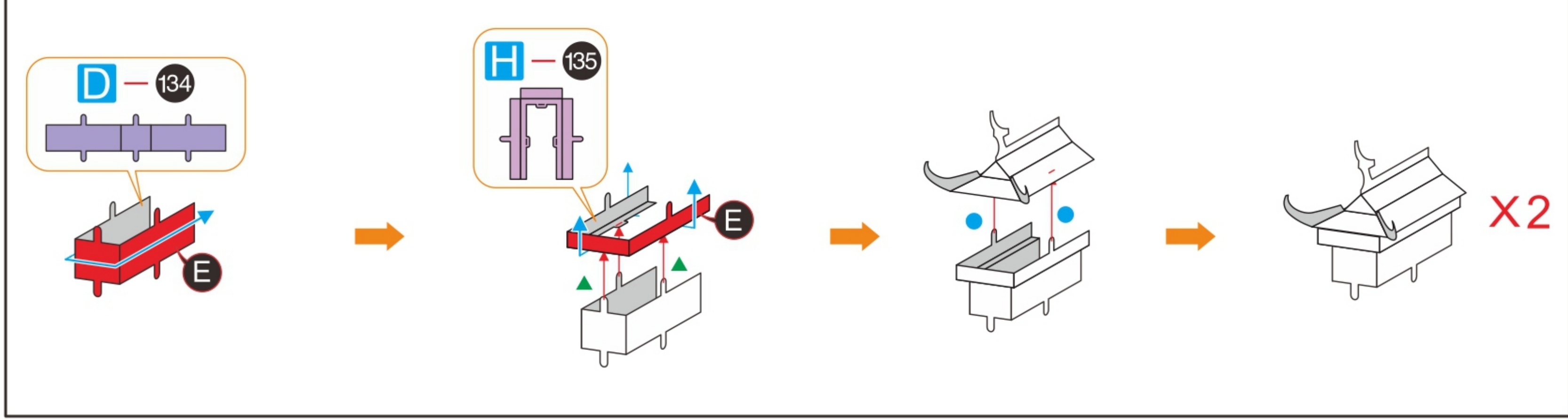
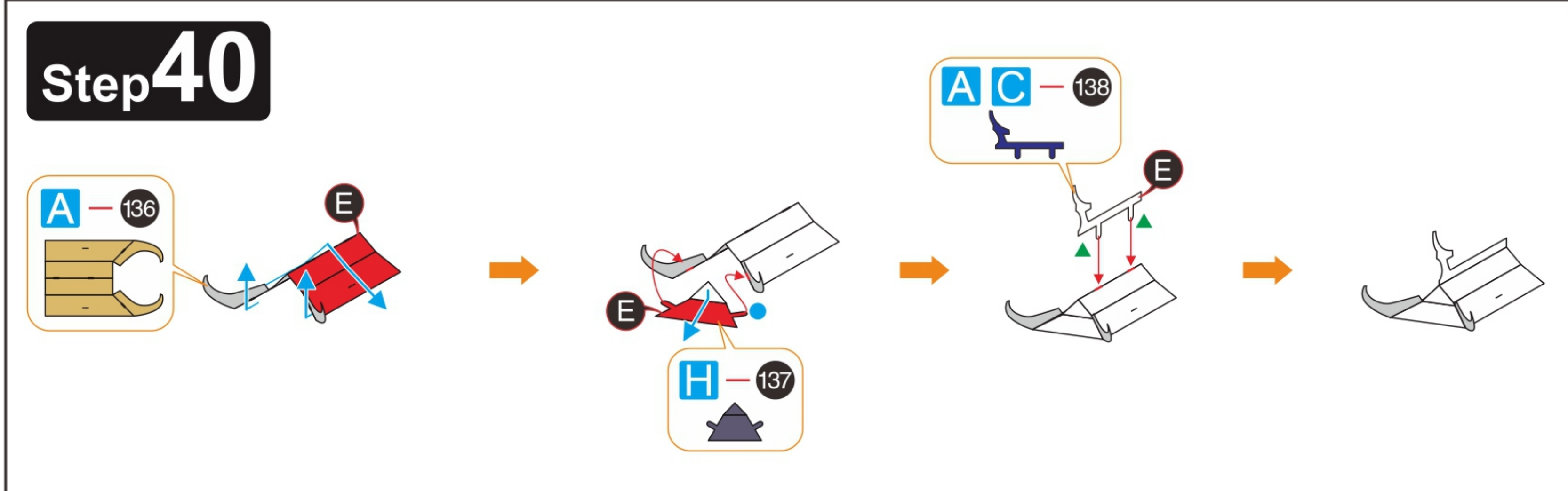
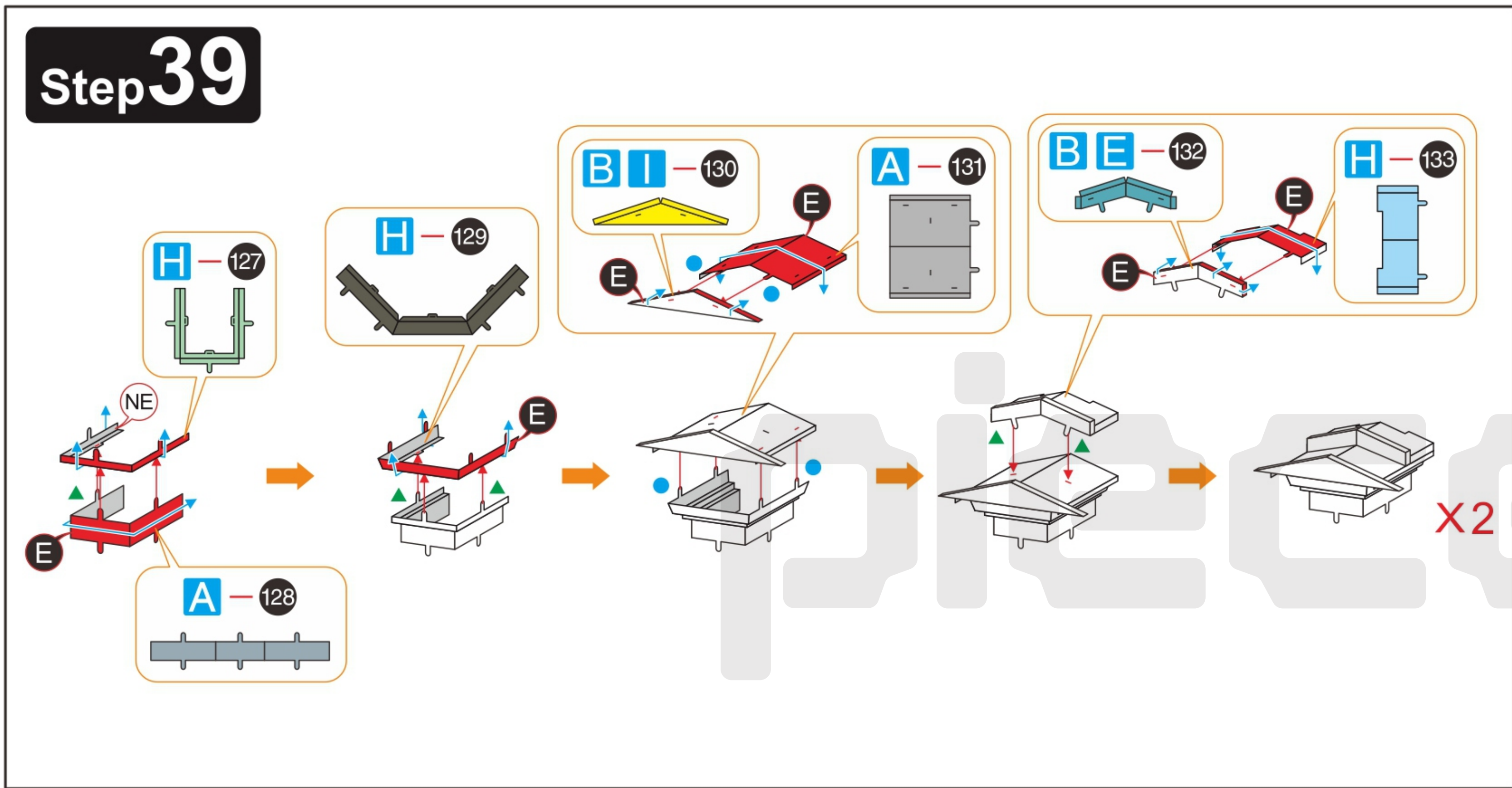
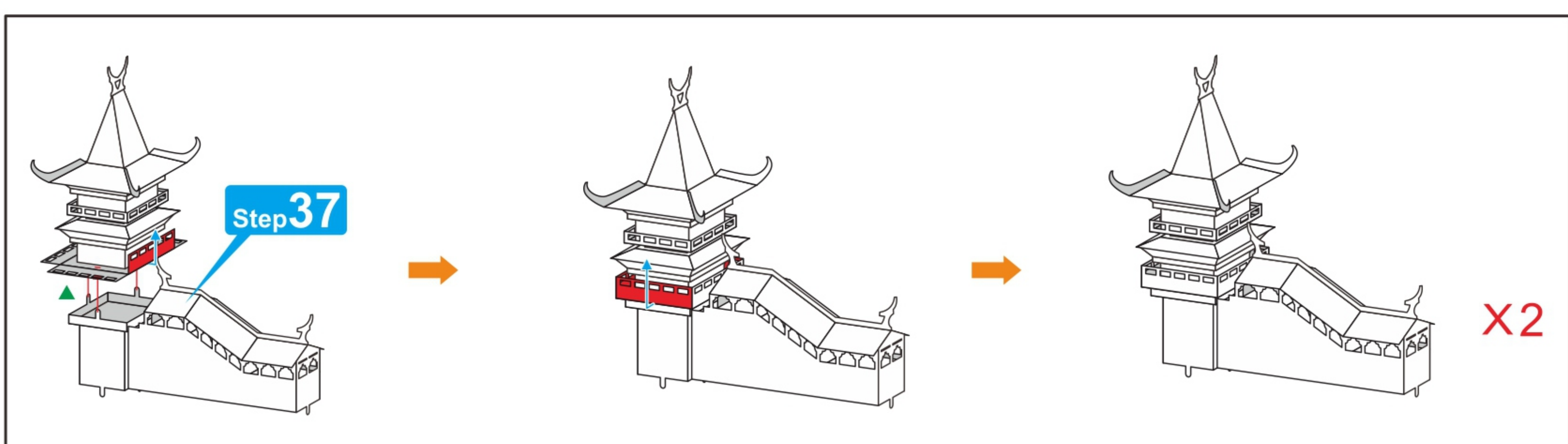

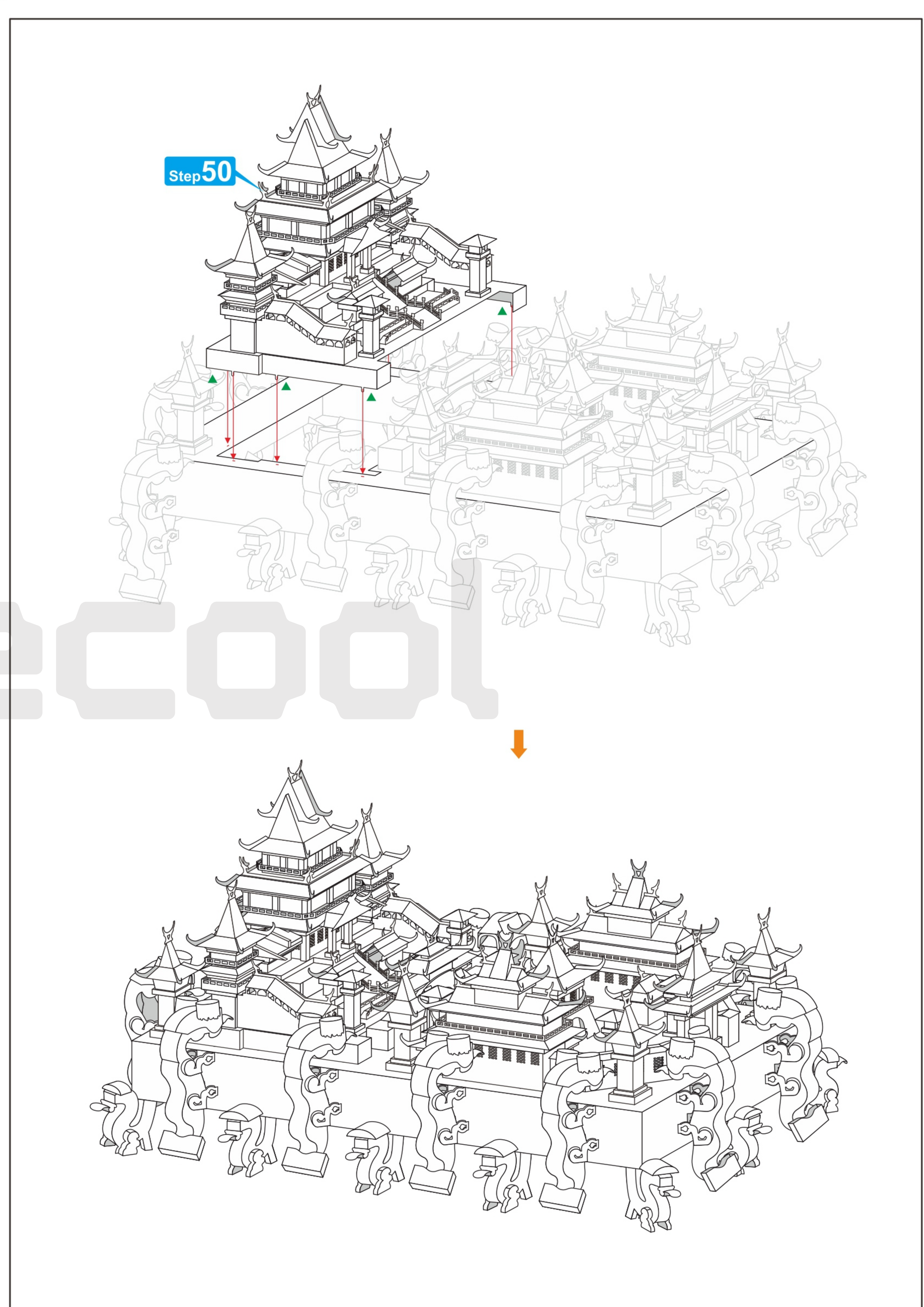
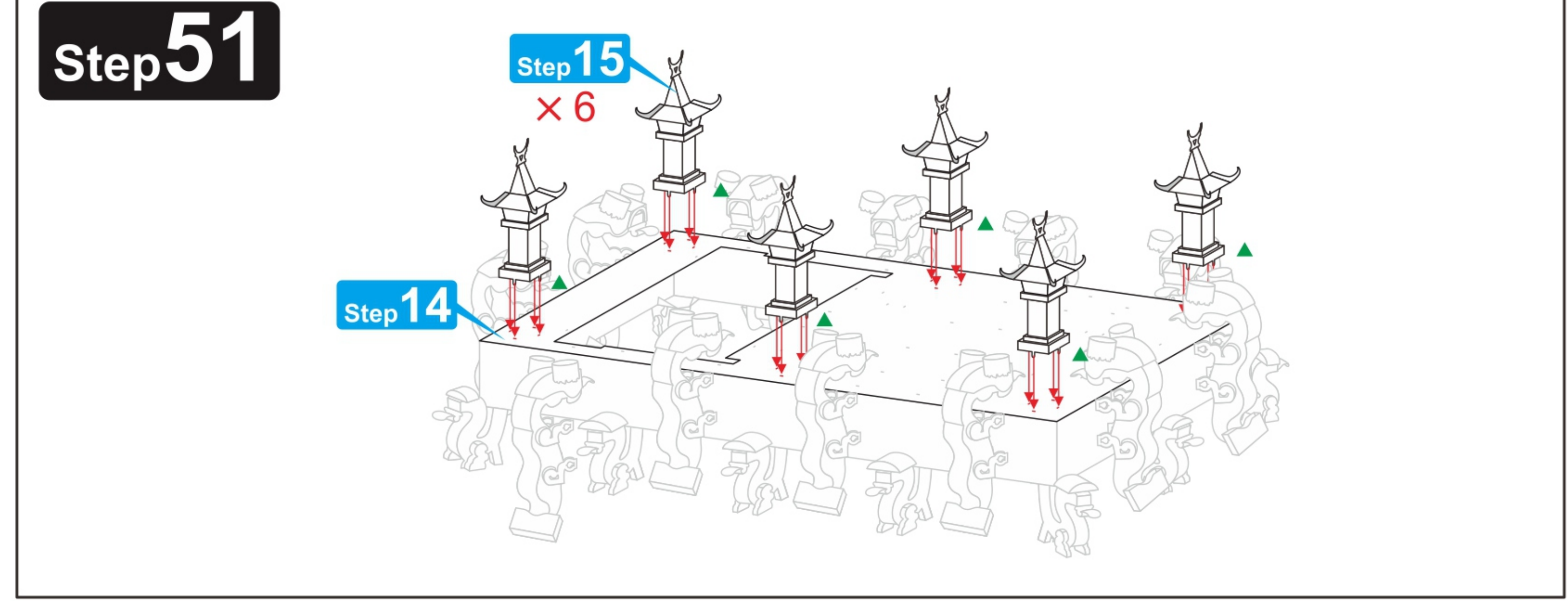
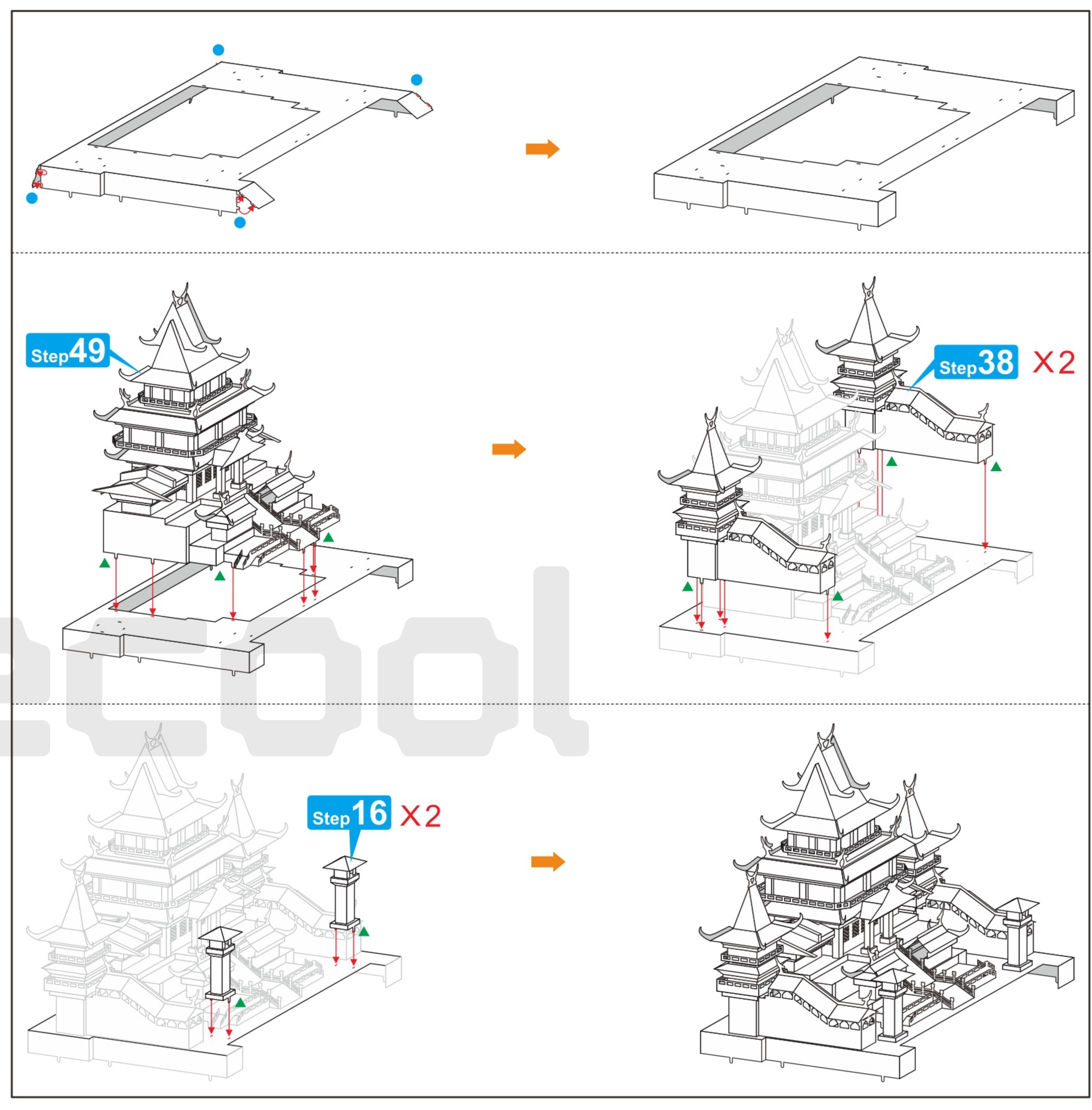
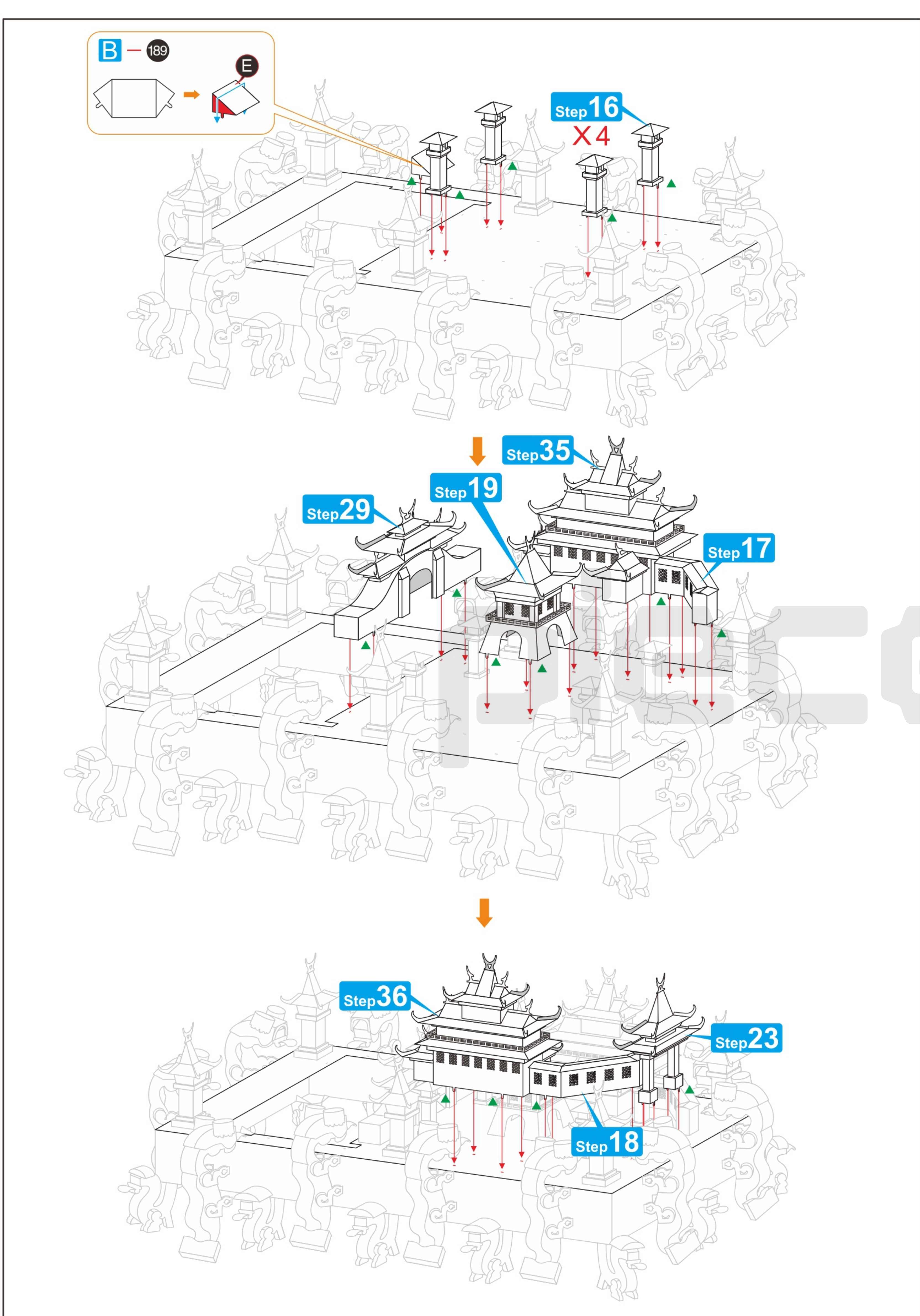
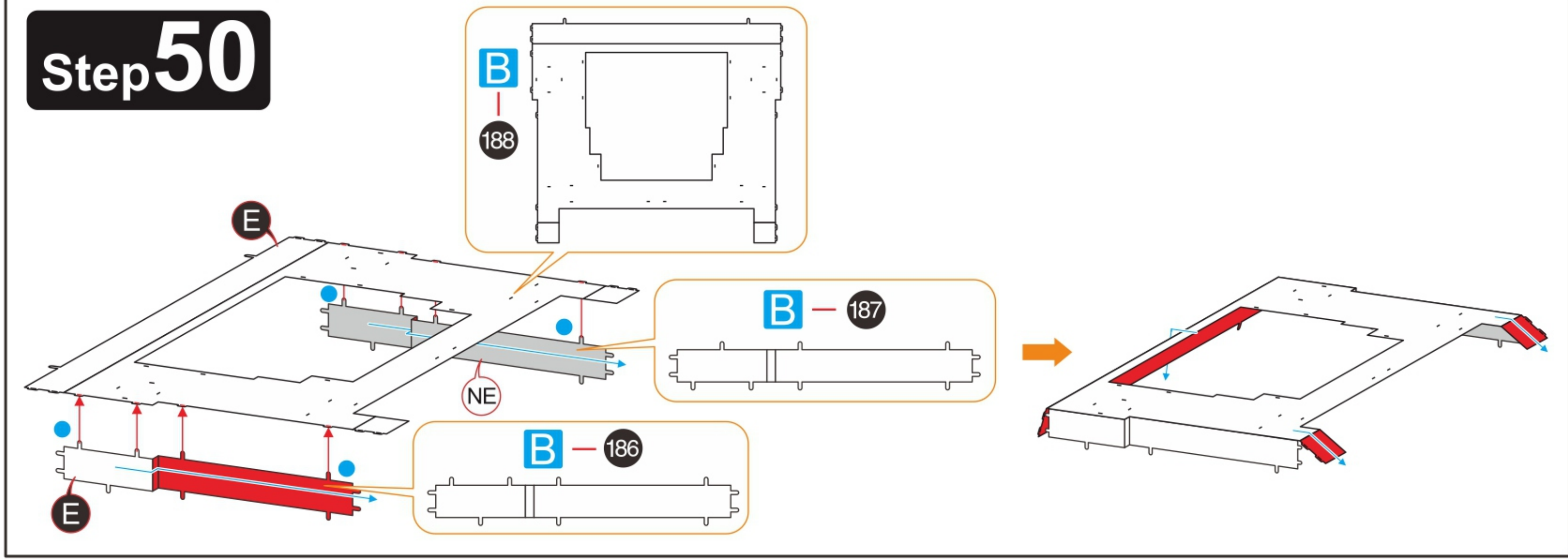
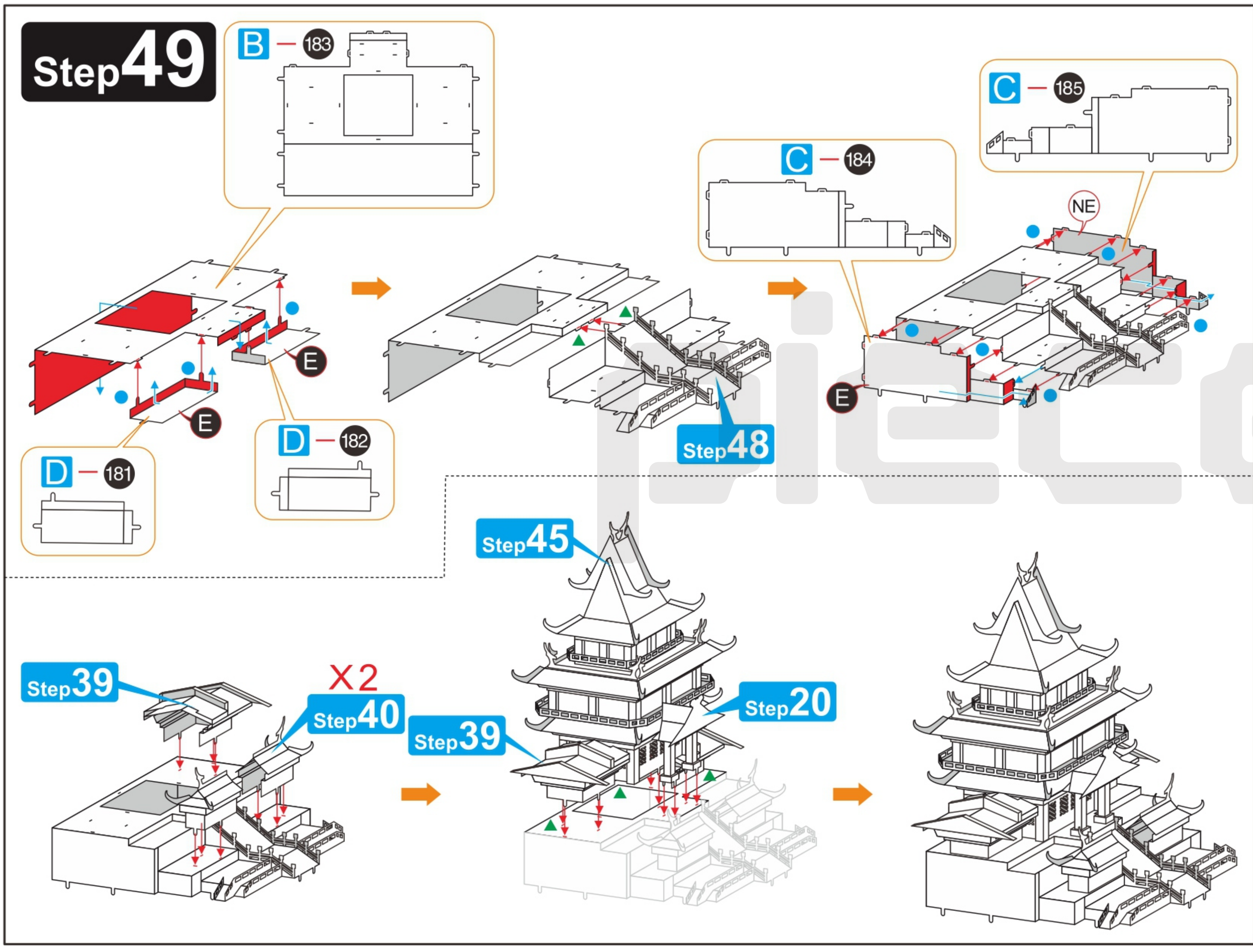
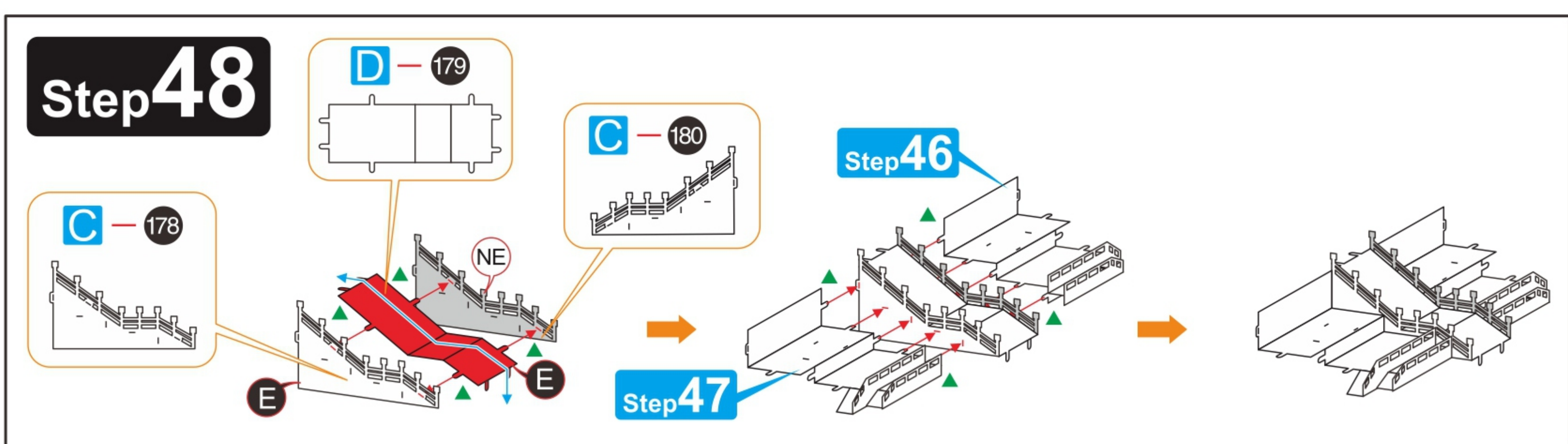

21 22  
23 24