

Hera  
HP253



CP-ASSY-HP253#-A1-20220526

## Installation Reminder

• Prepare tools:

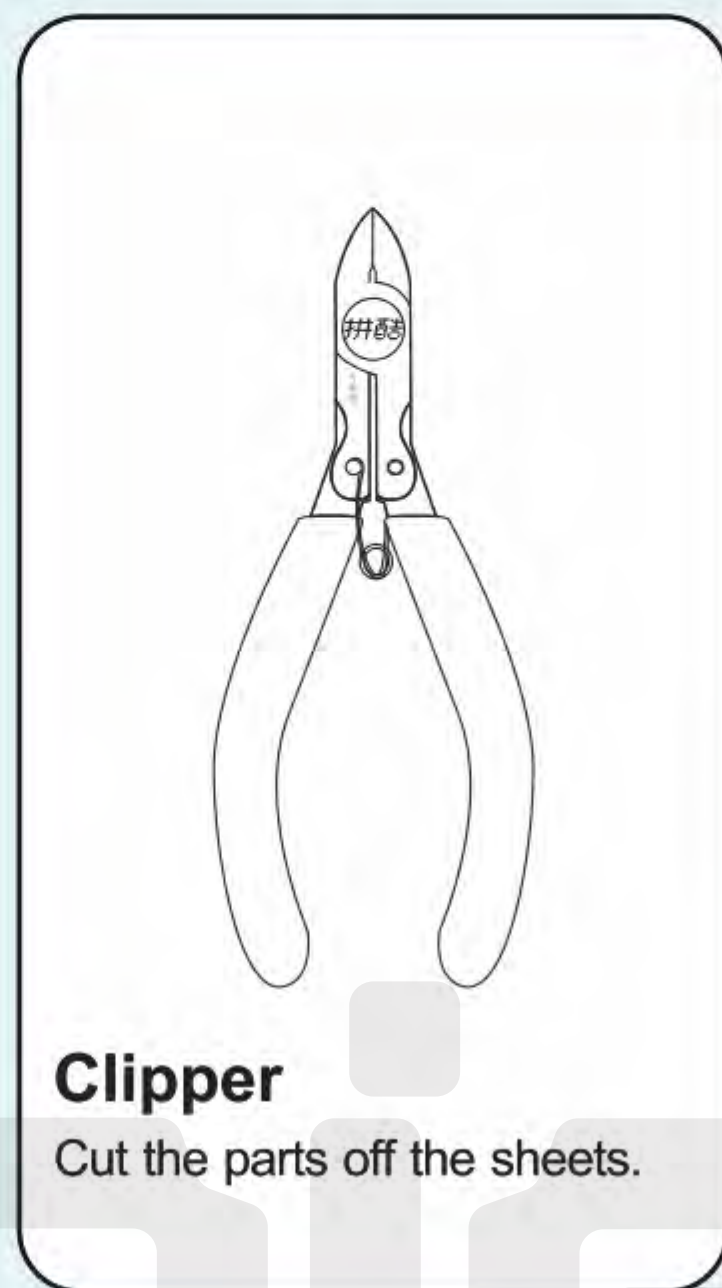

**Clipper**

Cut the parts off the sheets.

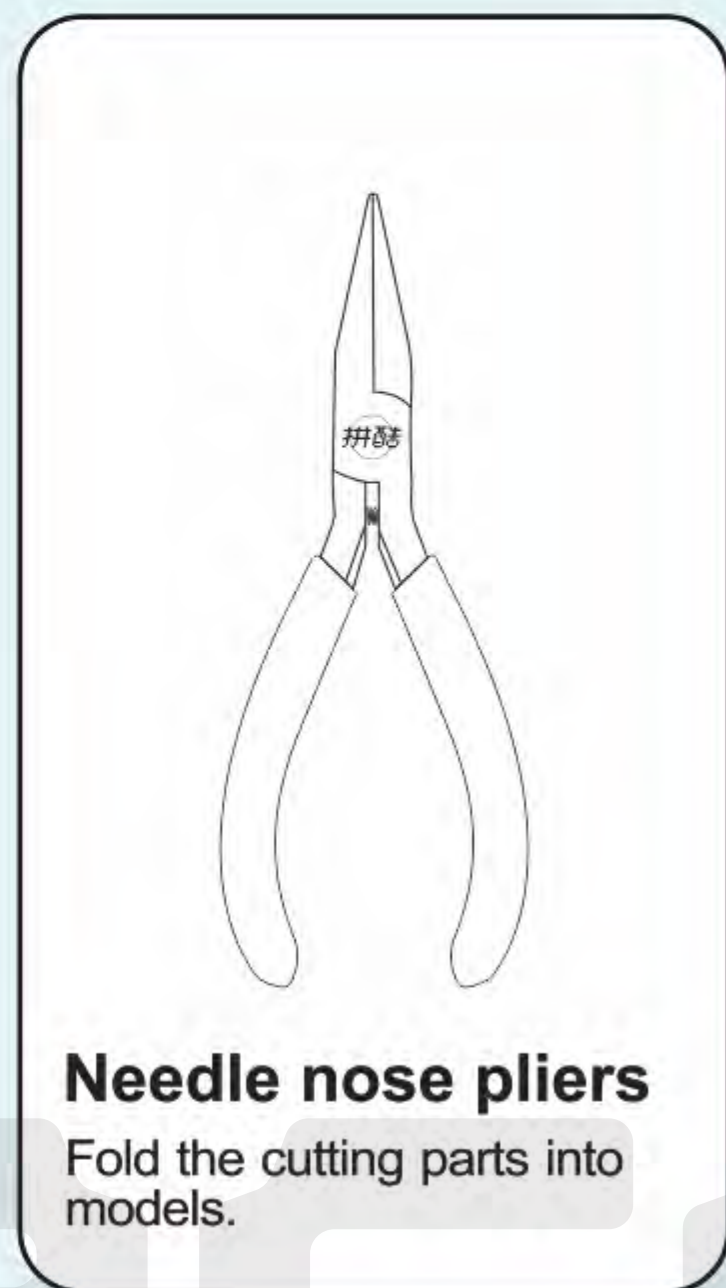

**Needle nose pliers**

Fold the cutting parts into models.

It is recommended to use piececool authentic assembly tools to build or fix the design. It is tailor made for the metal pieces and user friendly.

**WARNING** – Please handle metal sheets with care. The parts may have sharp edges that could cut or scratch skin. Keep away from children.

## • Installation Method:

### a. Remove the parts

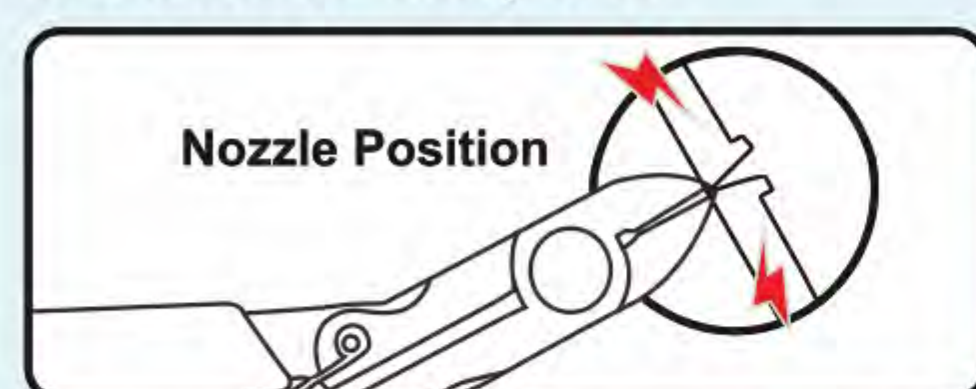

Please use the clipper to cut the nozzle position and remove the parts.

### b. Identify the parts

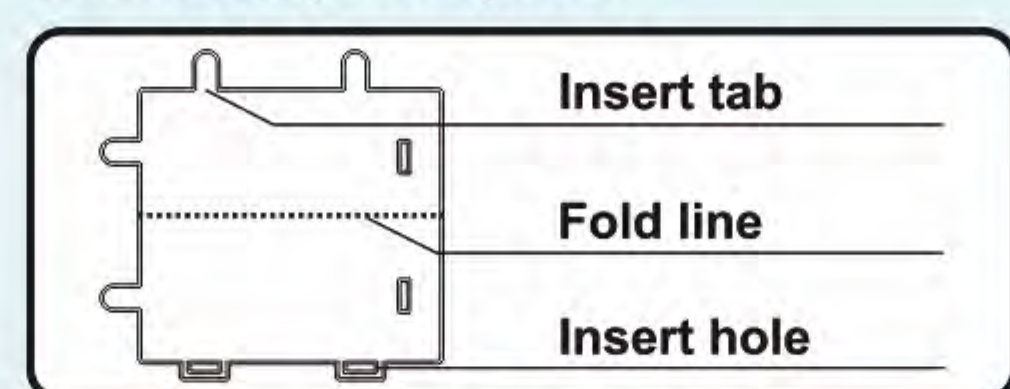

Identify the insert tab, fold line and the insert hole.

### c. Folding the parts

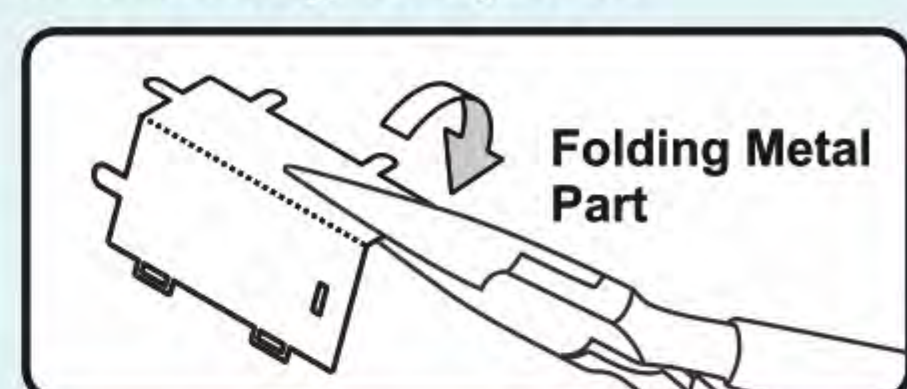

Please use the needle nose pliers to fold the cutting parts into models.

### d. Retaining the parts

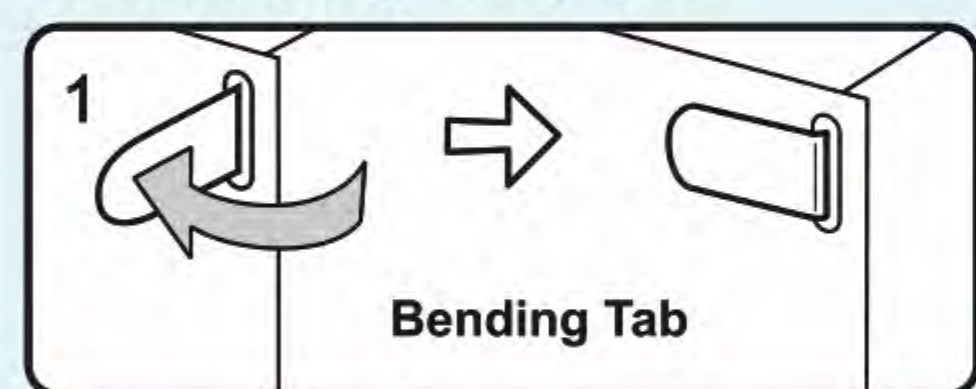

Insert the hole, bending tab with angle 90°

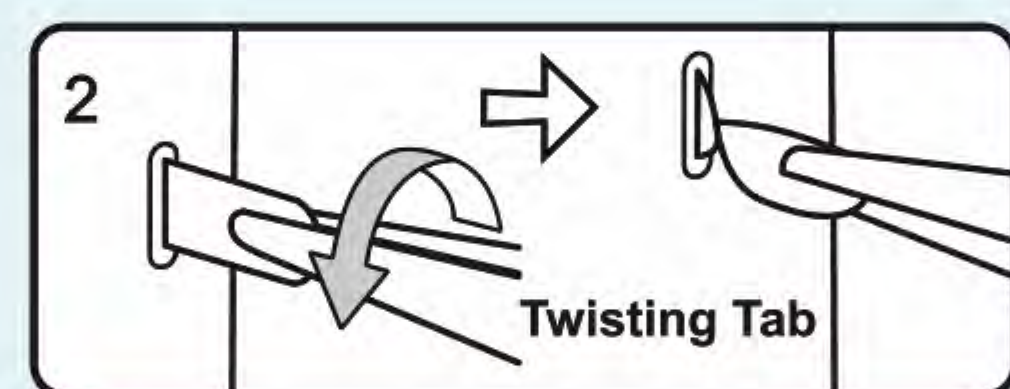

Insert the hole, twisting tab with angle 90°

## • Attention:

- E** Engraved / Color side
- NE** Non-engraved / Silver side
- !** Attention Point
- |** Keep the parts symmetrical

When cutting metal parts, please do not cut the "insert tab" as "nozzle position". Only cut the parts of the current step when cutting the parts. Do not cut all the parts at one time to avoid loss.

When encountering the parts of the folding line, please pay attention to the front and back of the metal sheet and the direction of the folding. According to the direction indicated in the instruction, cut lightly and fold slowly. It is best to fold it once. Do not fold it repeatedly to avoid damage to the parts.

## Assembly Guide

### Step 01

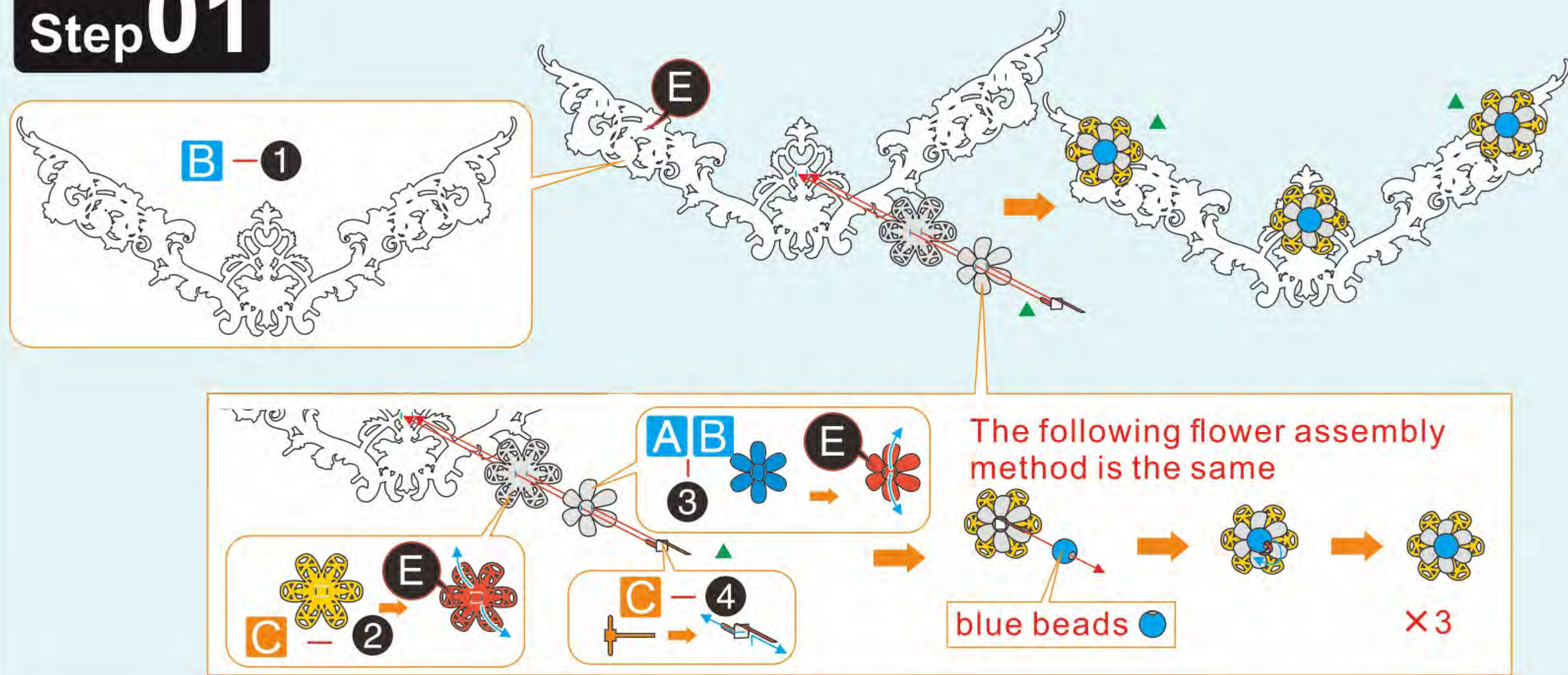

### Step 02

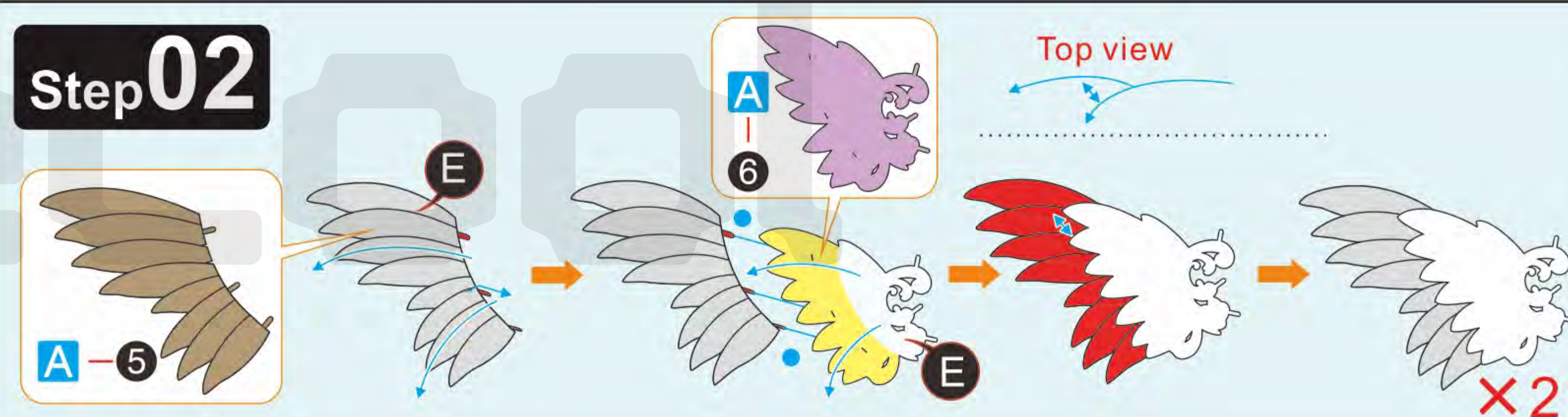

### Step 03

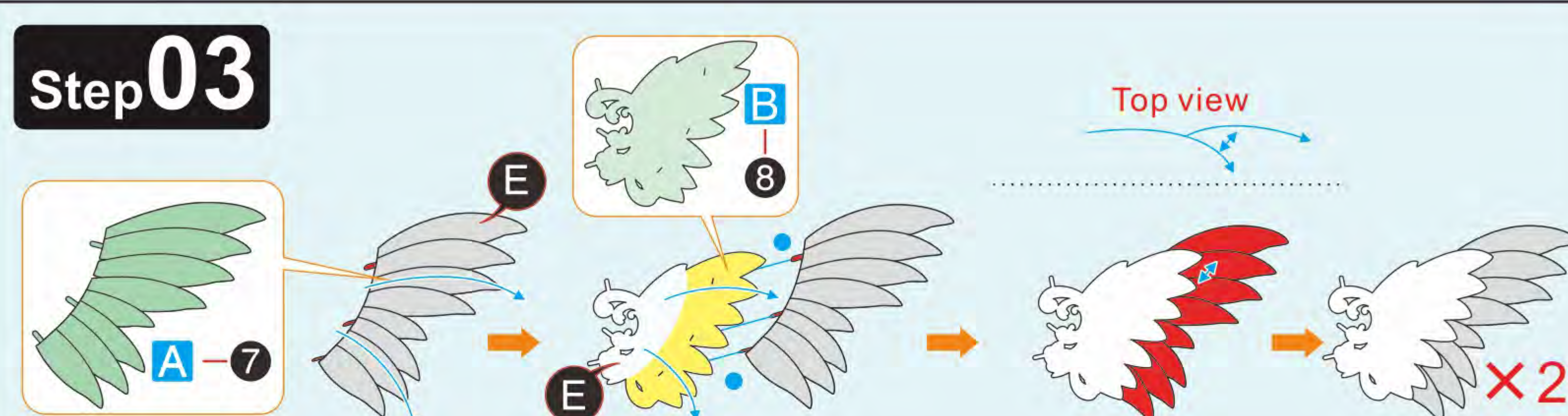

### Step 04

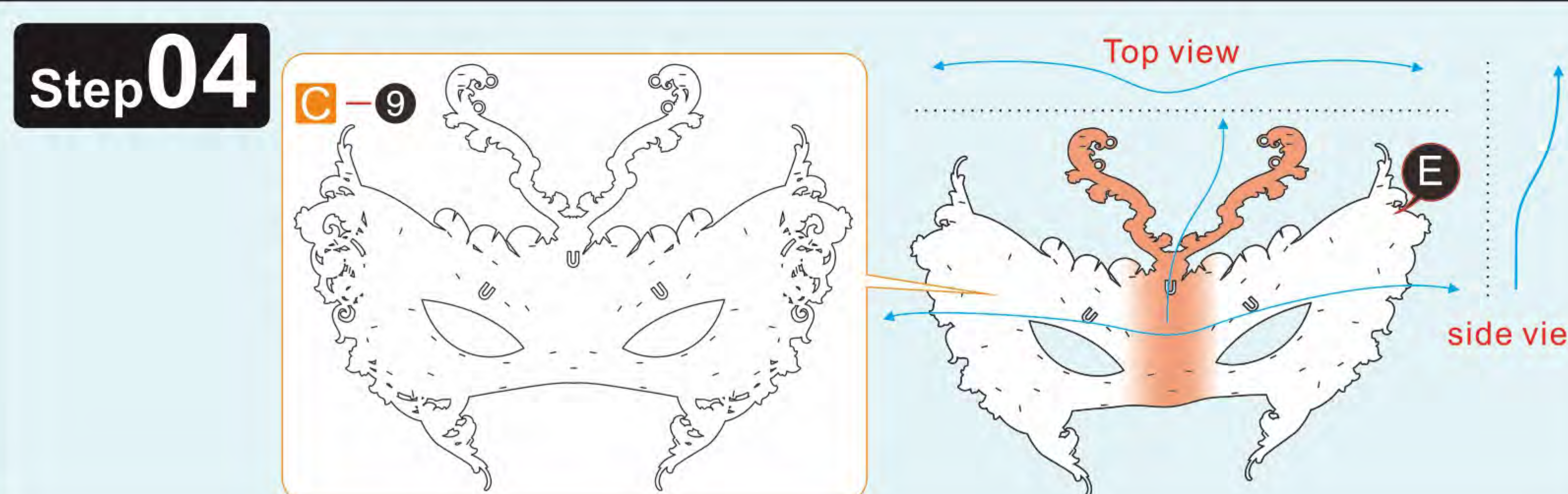

### Step 05

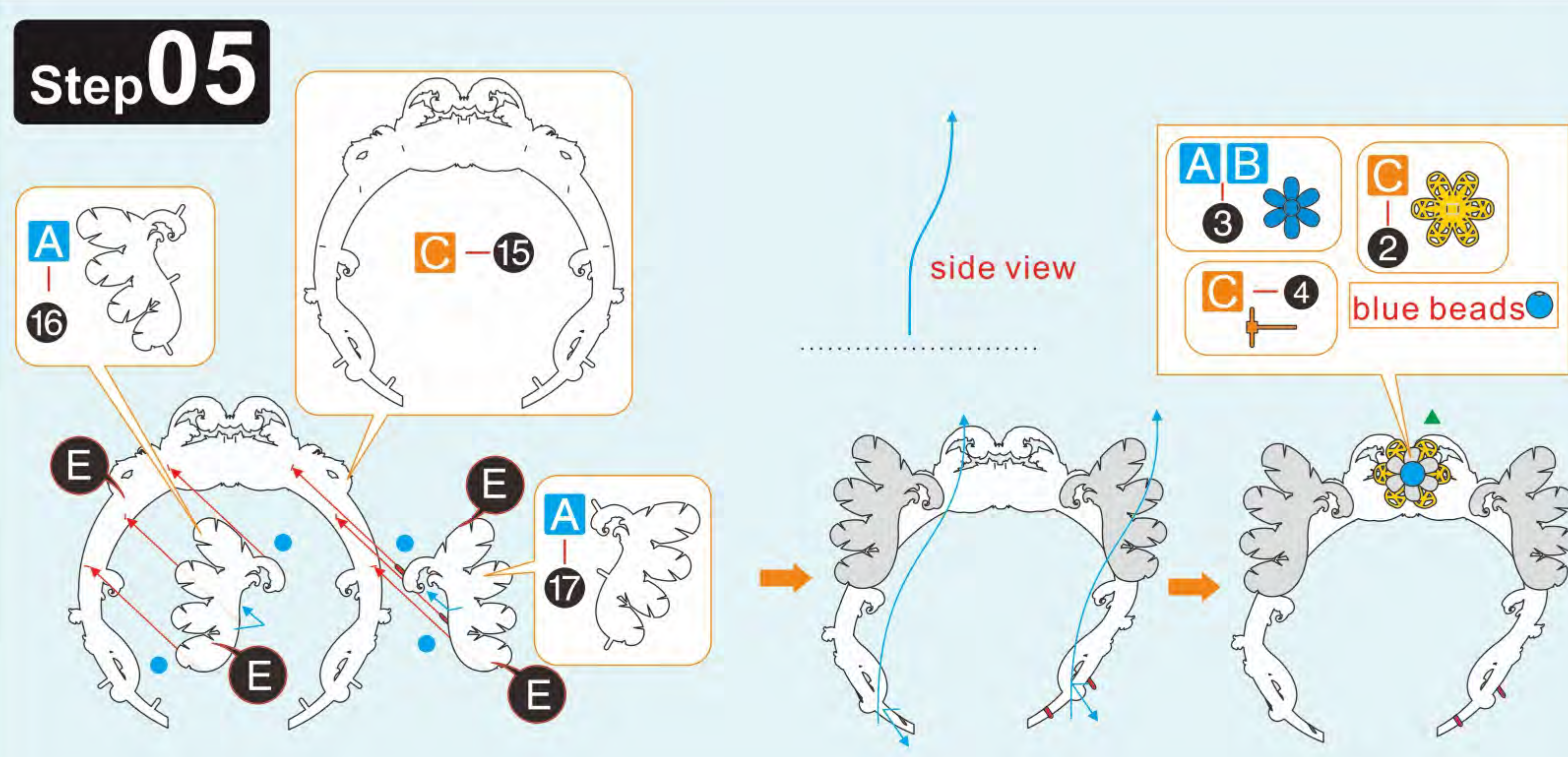

### Step 06

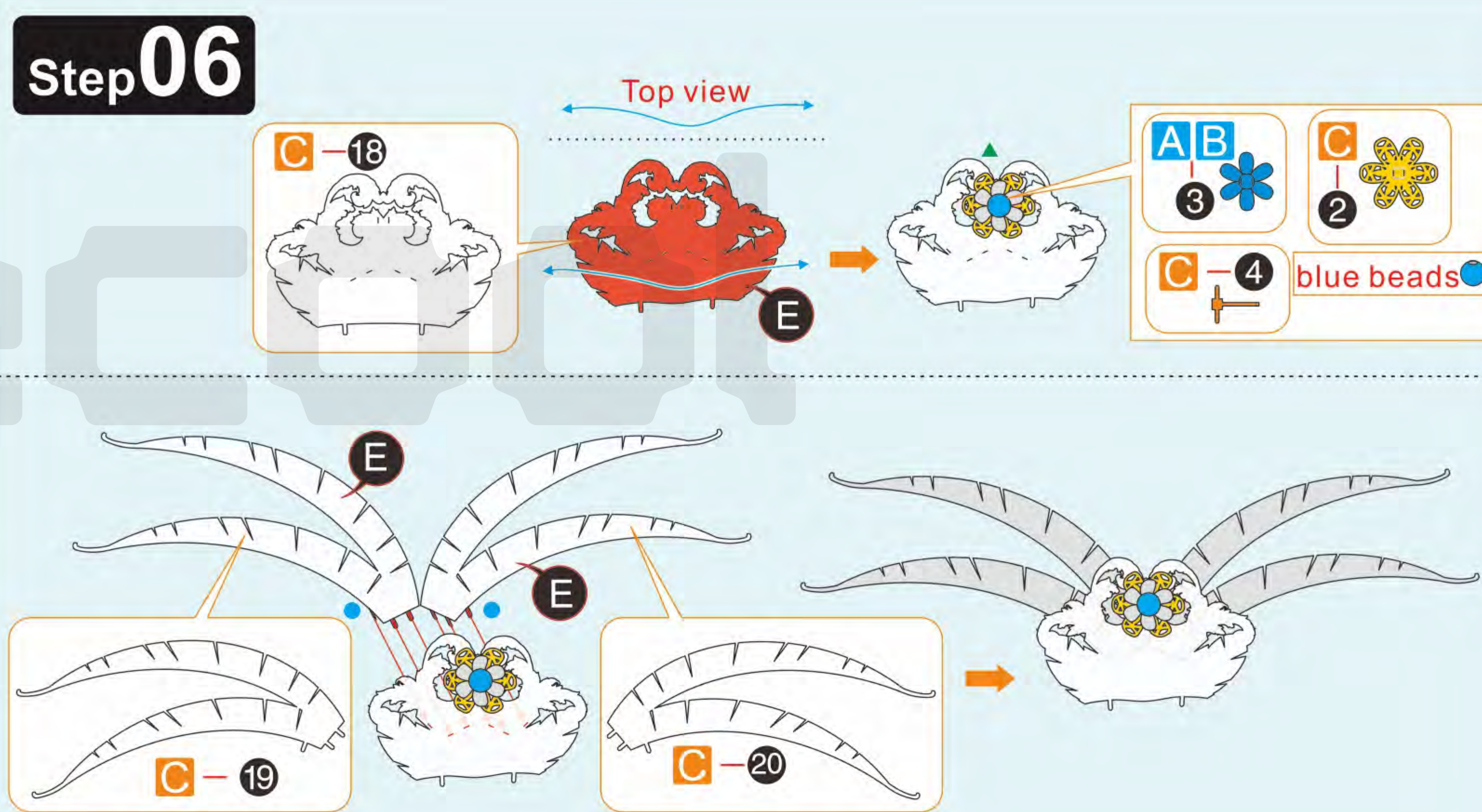

### Step 07

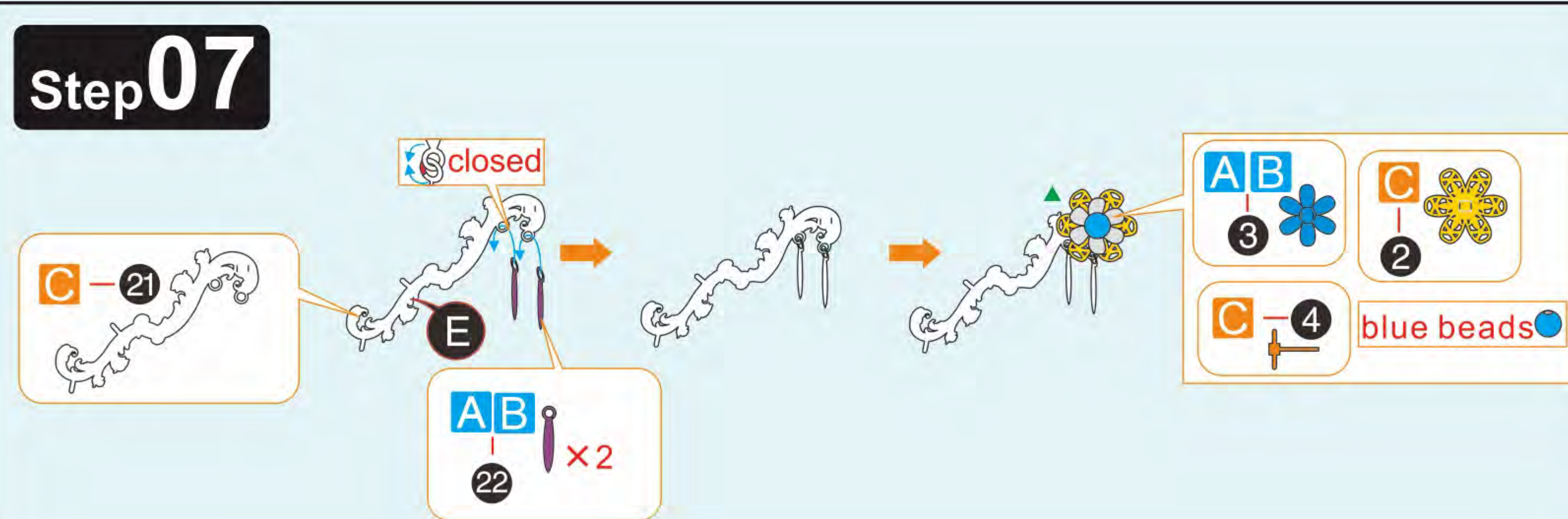



# Step 08

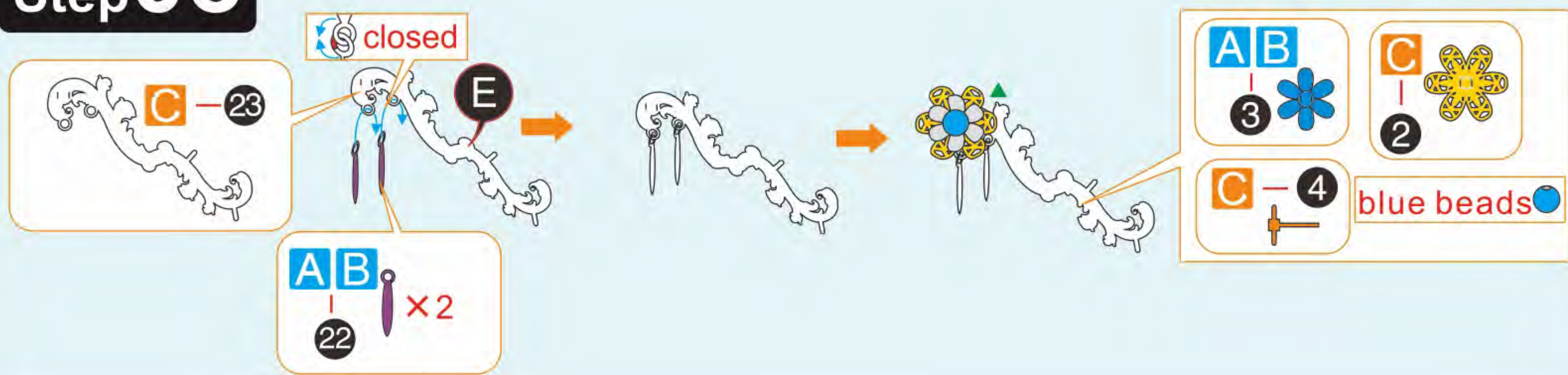

# Step 09

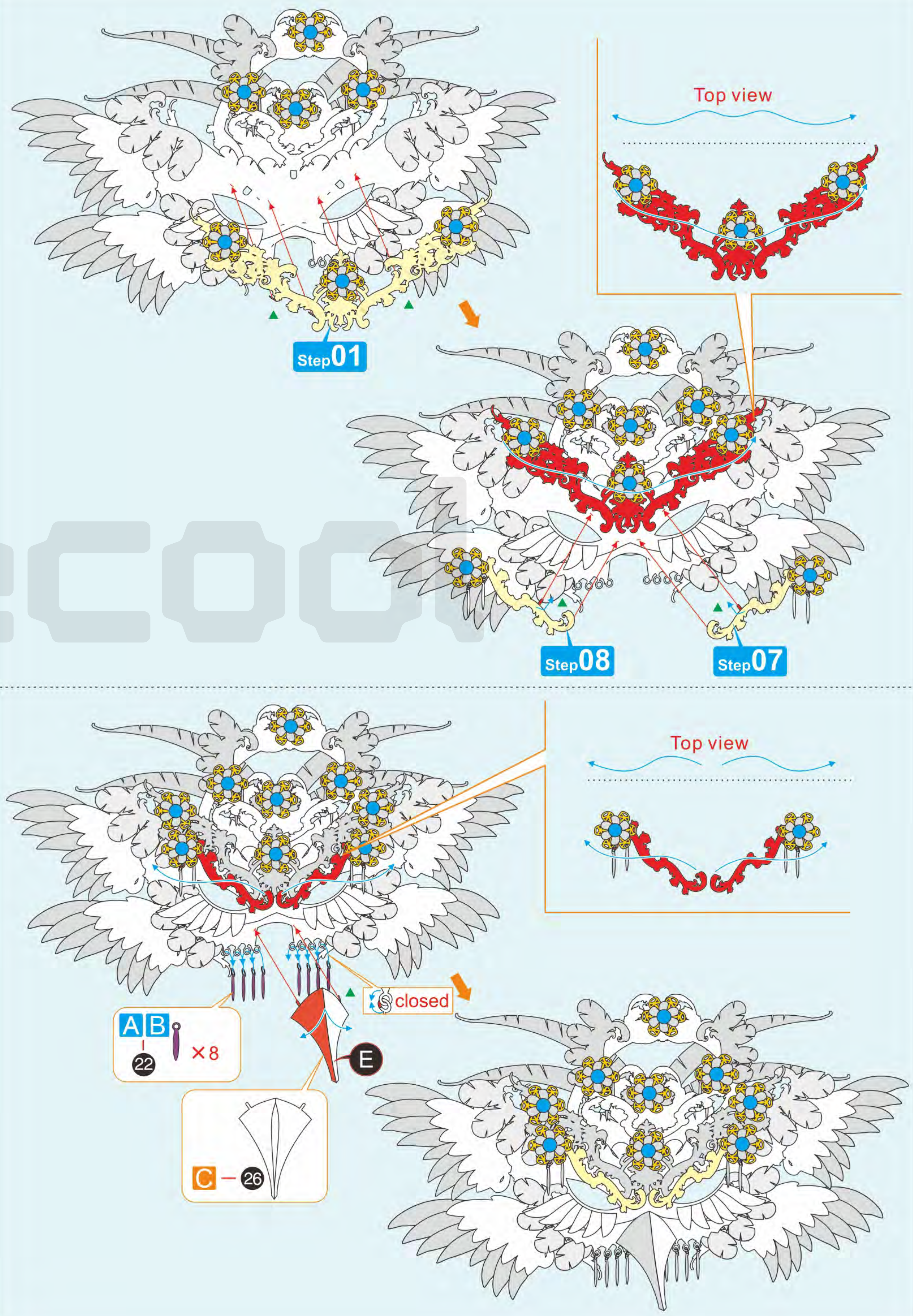
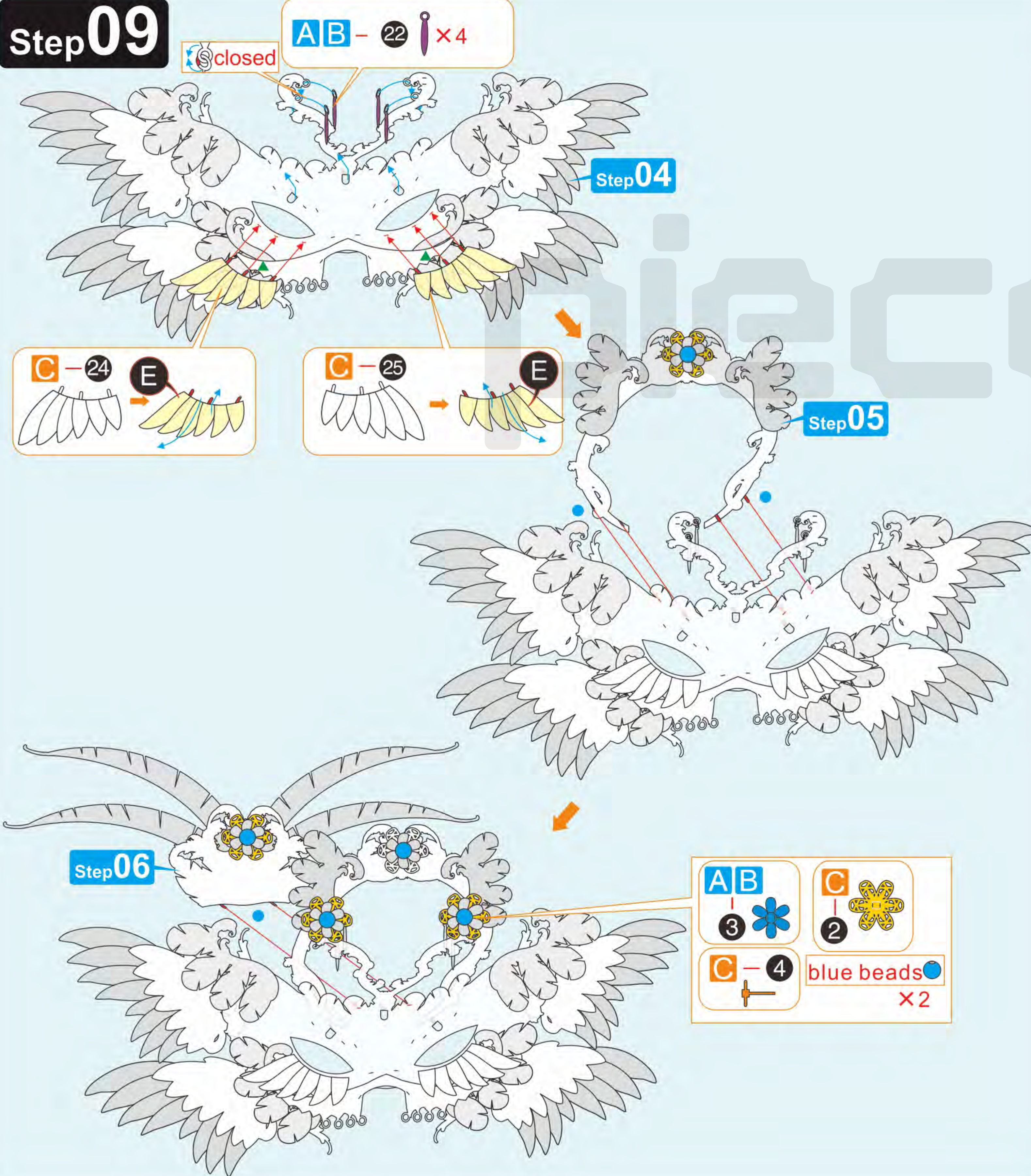

# Step 10

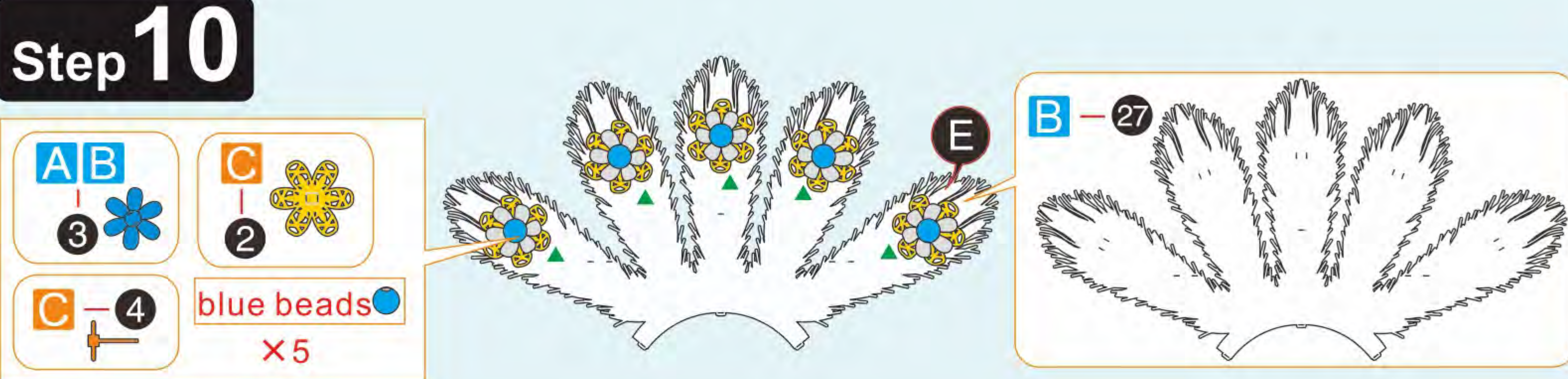

# Step 11

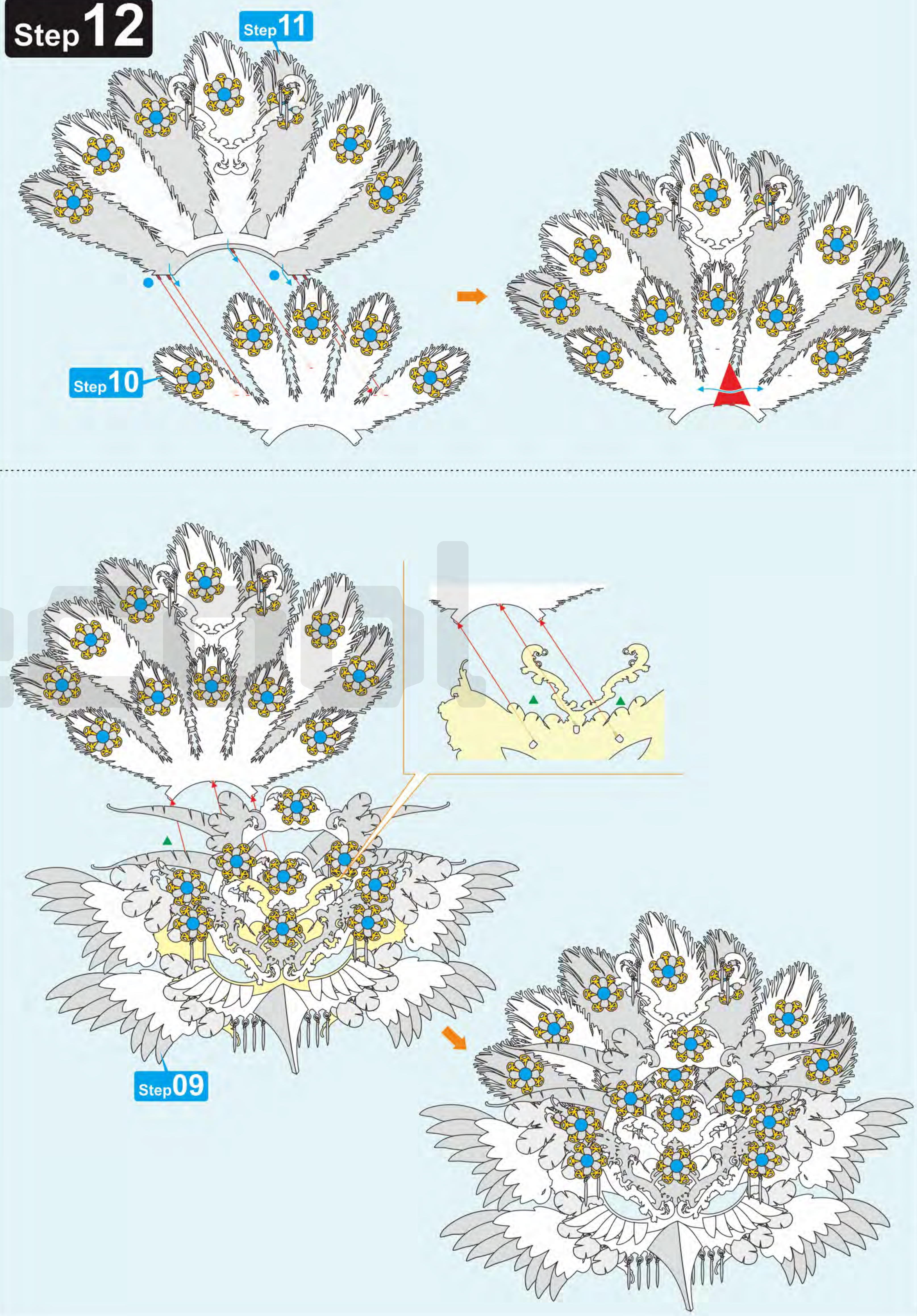
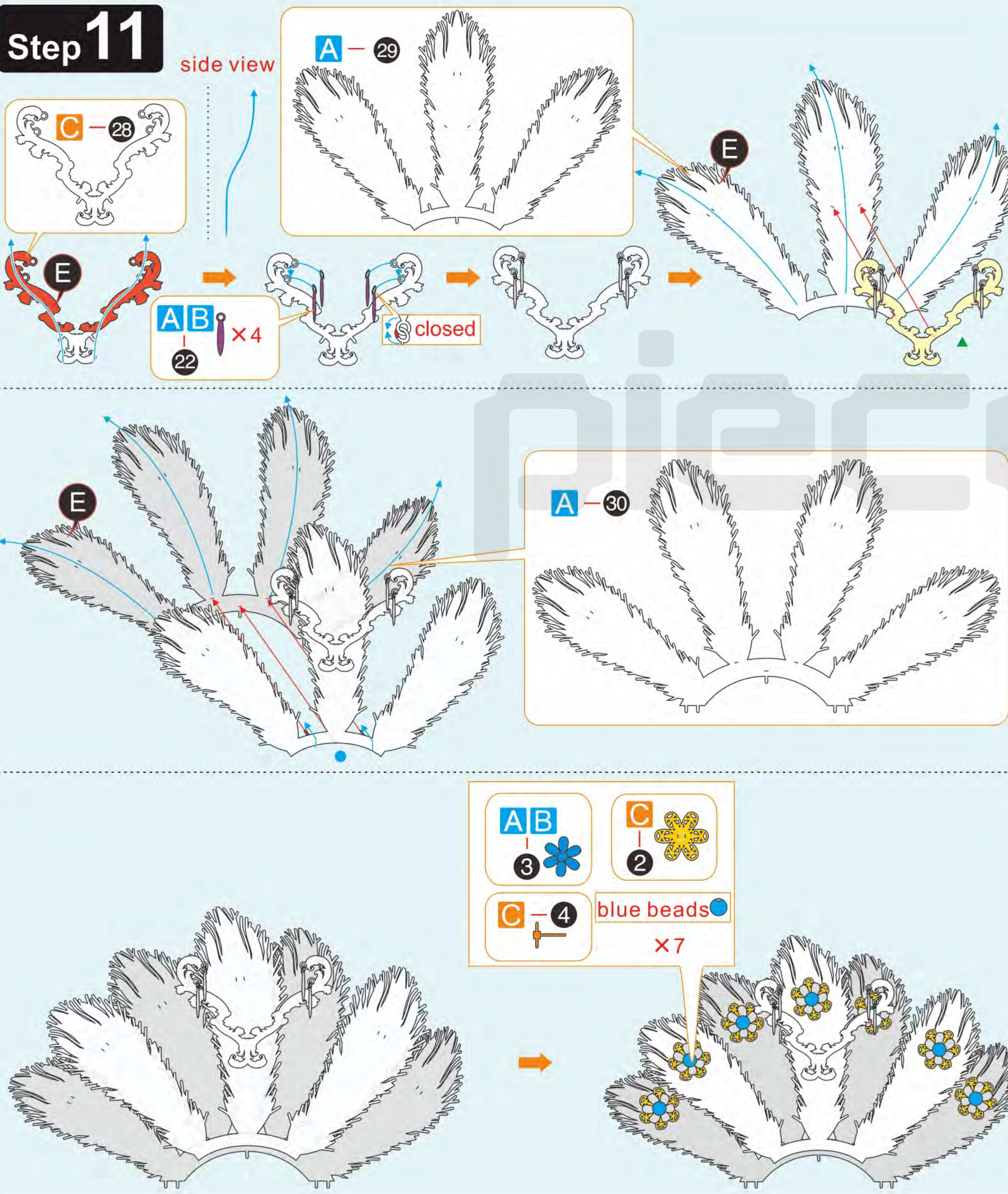



# Step 13

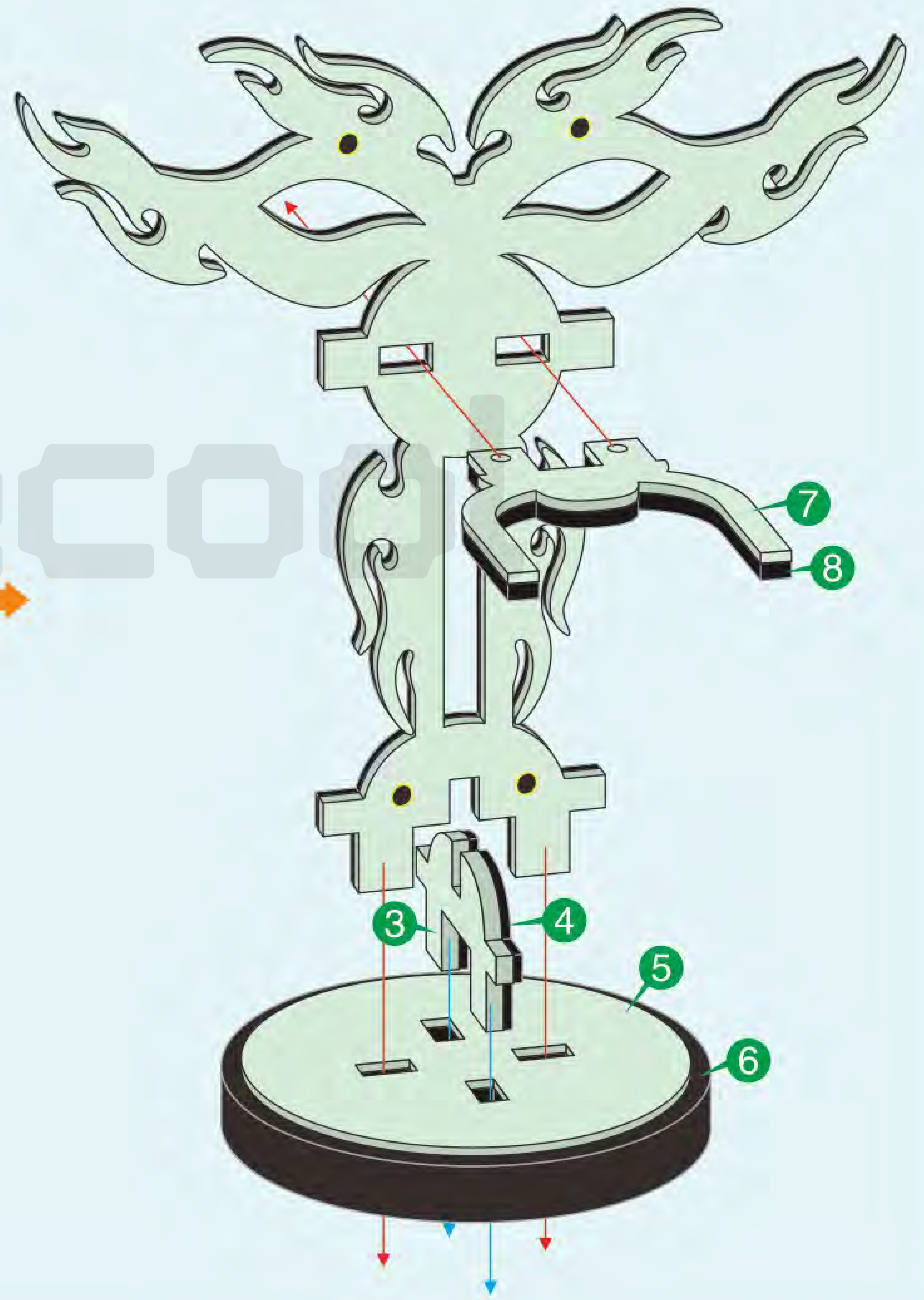

Black Nylon Rivets X2

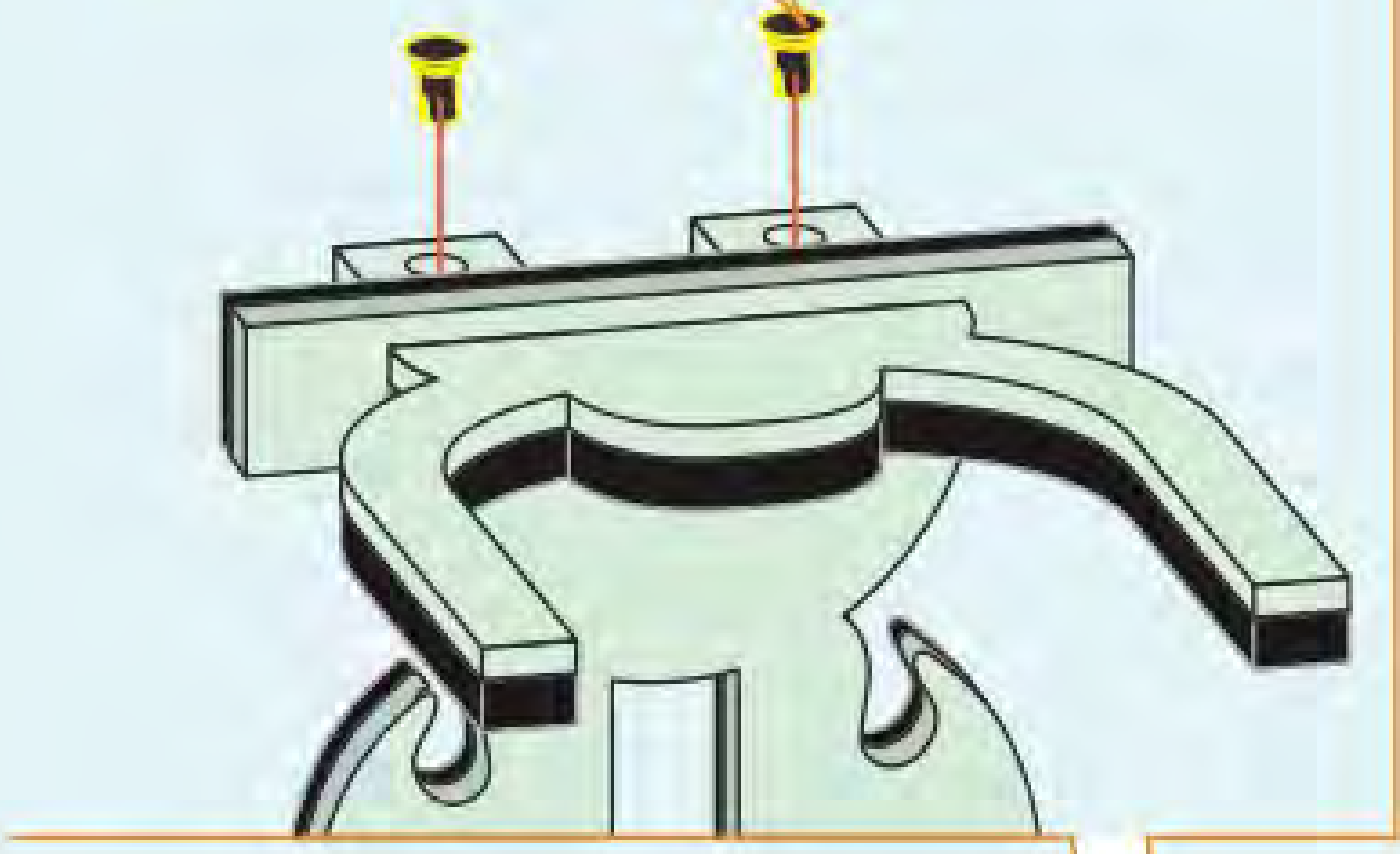

# Step 12

