

ARC DE TRIOMPHE 凱旋門 HP008

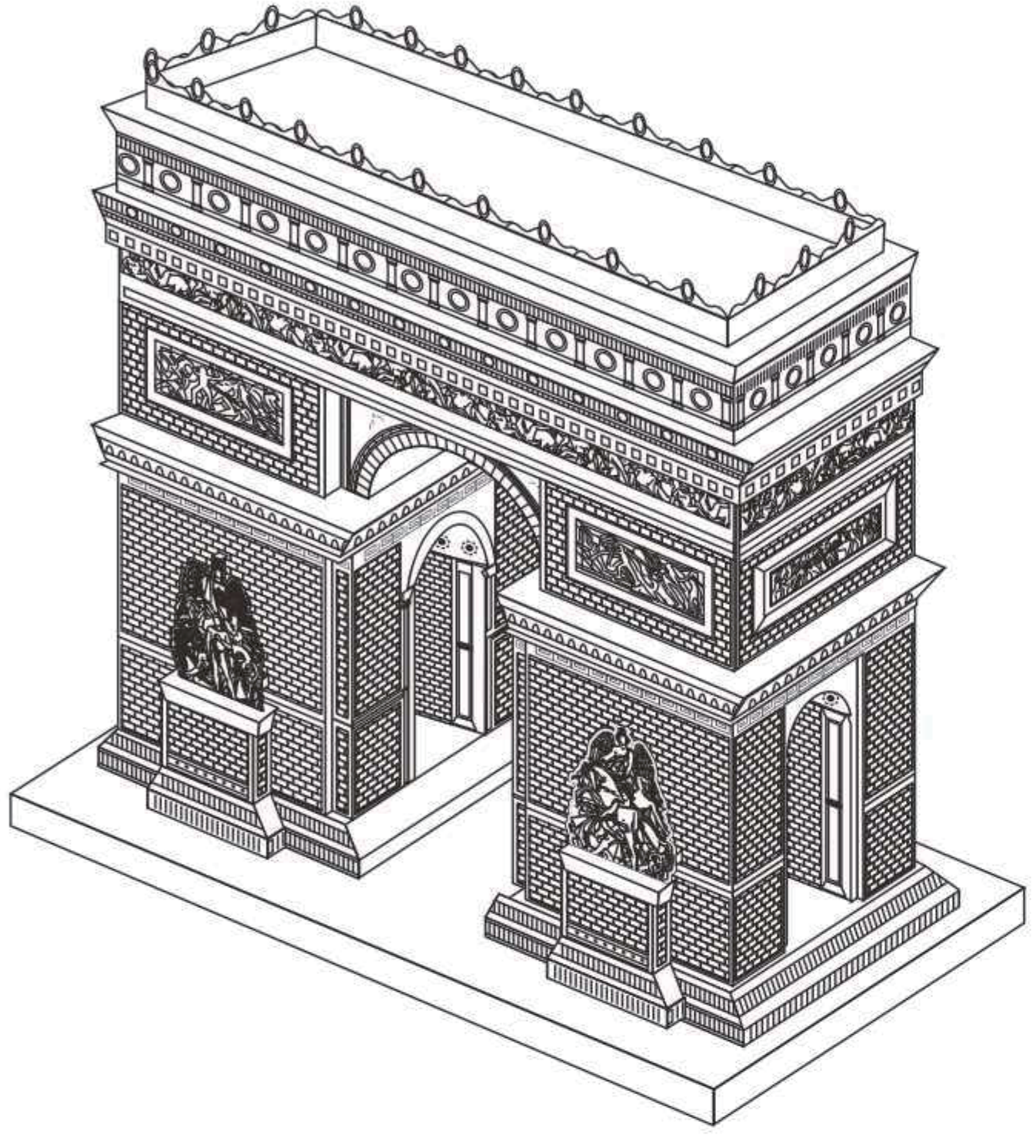

CP-ASSY-HP008#-A1-20200725

Installation Reminder / 拼前需知

- Prepare tools / 準備工具

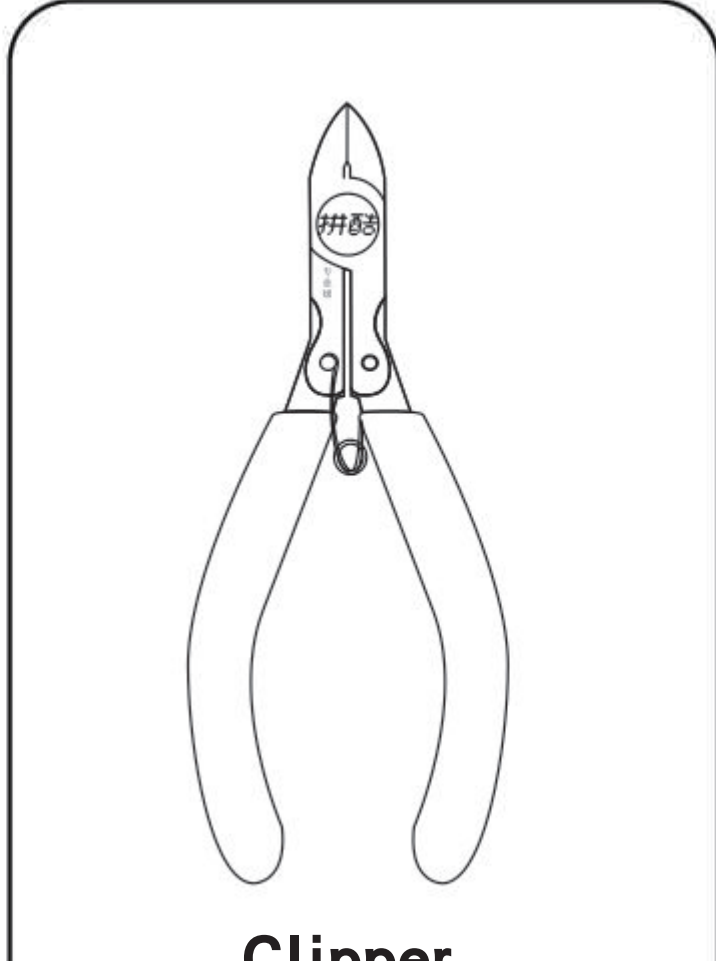

Clipper
Remove parts from sheets.
水口鉗工具
修剪金屬片板件上的零件水口位。

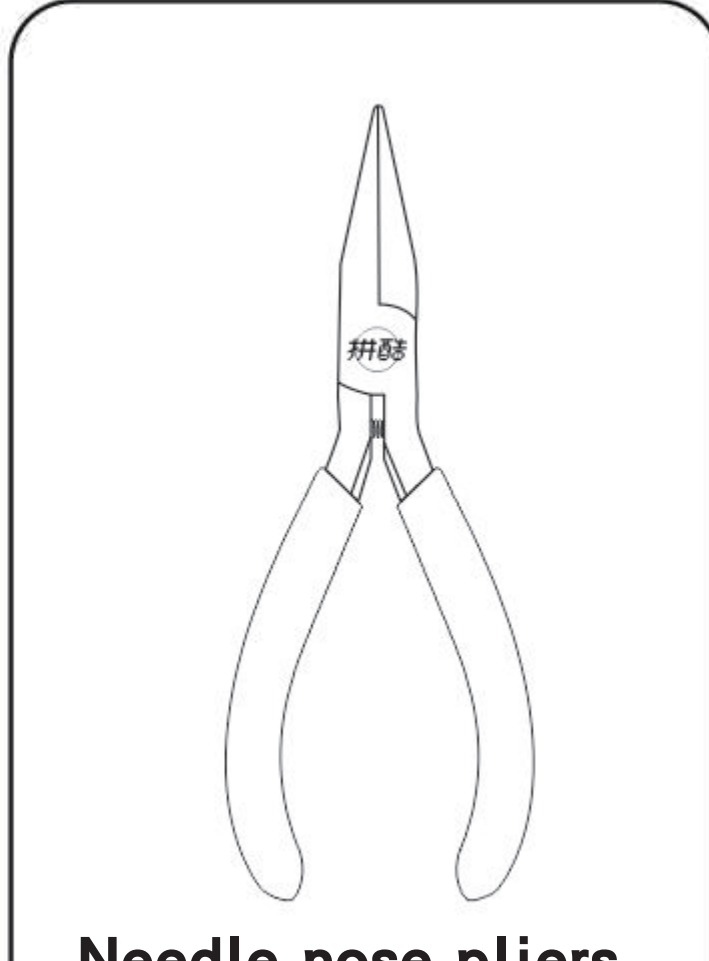

Needle nose pliers
Fold parts to assemble the model.
尖嘴鉗工具
彎折金屬零件上的折疊線和扣點。

It is recommended to use piececool authentic assembly tools to build or fix the design. It is tailor made for the metal pieces and user friendly. 建議使用拼酷正品拼裝工具(水口鉗、尖嘴鉗), 拼裝時更省力, 拼裝後作品更精細、美觀!

! Please handle the metal trim carefully to prevent scratches. 組裝時請小心處理金屬零件, 以防劃傷。

Installation Method / 拼裝方法:

a. Remove the parts / 取下零件:

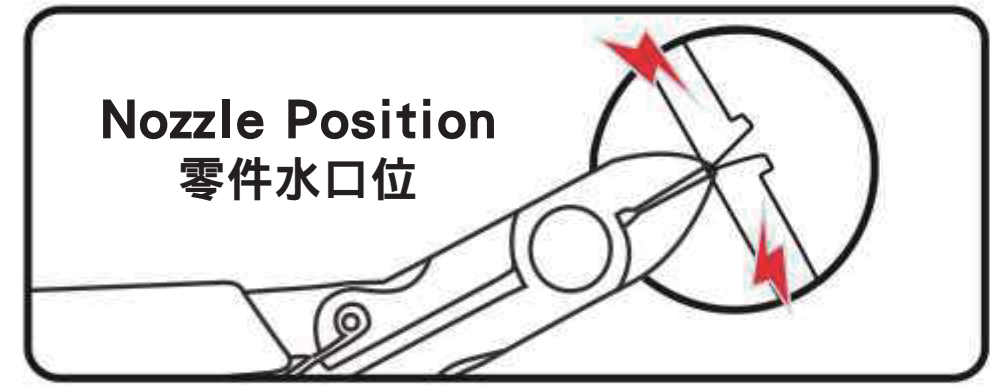

Please use the clipper to cut the nozzle position and remove the parts. 使用水口鉗剪斷金屬零件上的水口, 將需要的金屬零件從金屬片板件取下。

b. Identify the parts / 識別零件:

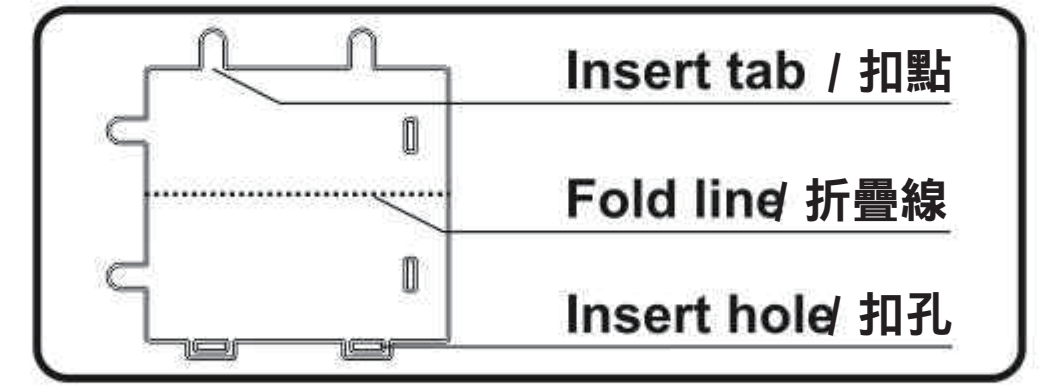

Identify the insert tab, fold line and the insert hole. 識別金屬零件上的扣點, 折疊線, 扣孔的樣子。

c. Folding the parts / 折疊零件:

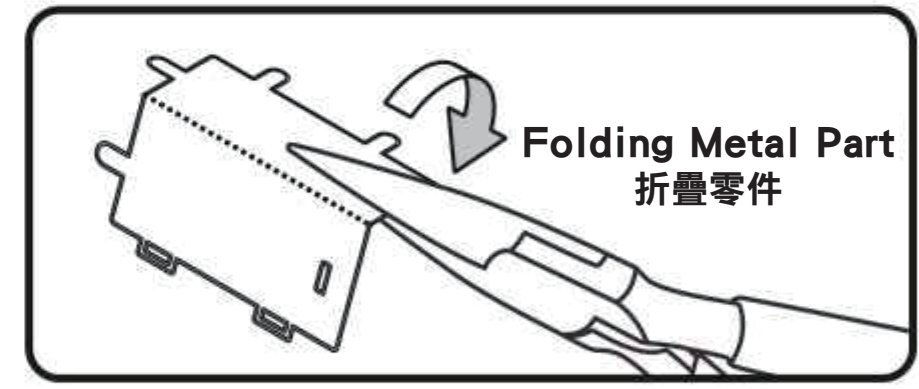

Please use the Needle nose pliers to fold the cutting parts into models. 使用尖嘴鉗, 參照拼裝說明書將金屬零件折成形狀。

d. Retaining the parts / 固定零件:



Insert the hole, bending tab with angle 90°. 插入扣孔, 平折90°。

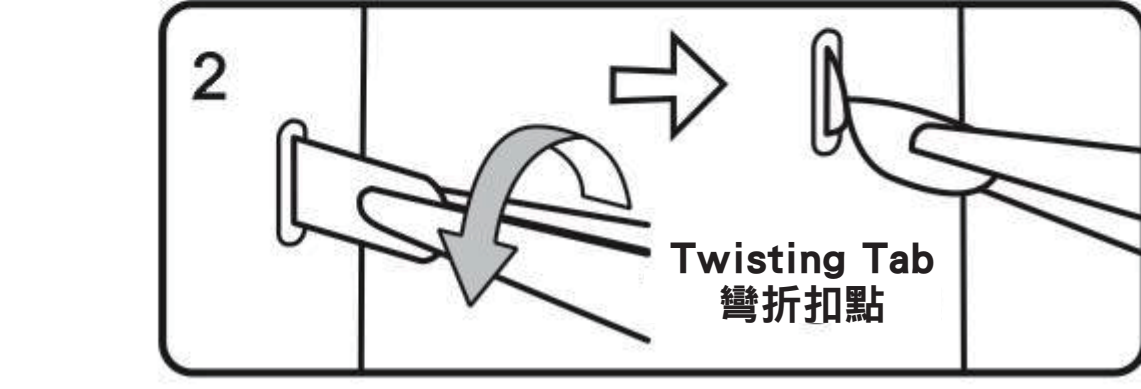

Insert the hole, twisting tab with angle 90°. 插入扣孔, 旋轉90°。

Attention / 注意事項:

- E** Engraved / Color side
顏色面 / 紋理面
- NE** Non-engraved / Silver side
非顏色面 / 非紋理面
- !** Attention Point
注意細節
- ||** keep the parts symmetrical
注意片對稱

When cutting metal parts, please do not cut the "insert tab" as "nozzle position". Only cut the parts of the current step when cutting the parts. Do not cut all the parts at one time to avoid loss.

When encountering the parts of the folding line, please pay attention to the front and back of the metal sheet and the direction of the folding. According to the direction indicated in the instruction, cut lightly and fold slowly. It is best to fold it once. Do not fold it repeatedly to avoid damage to the parts.

剪金屬零件時請剪零件“水口位”, 請勿將“扣點”當成“水口位”剪下, 每次剪零件時請僅剪當前步驟的零件, 切勿一次性將所有零件剪下, 避免丟失。

當遇到折疊線的零件, 請注意金屬片的正反面及拼折方向, 請按照說明書的方向, 輕剪慢折, 最好一次性折疊完成, 請勿反覆折疊, 避免零件損壞。

Assembly Guide / 拼裝步驟

Step 1

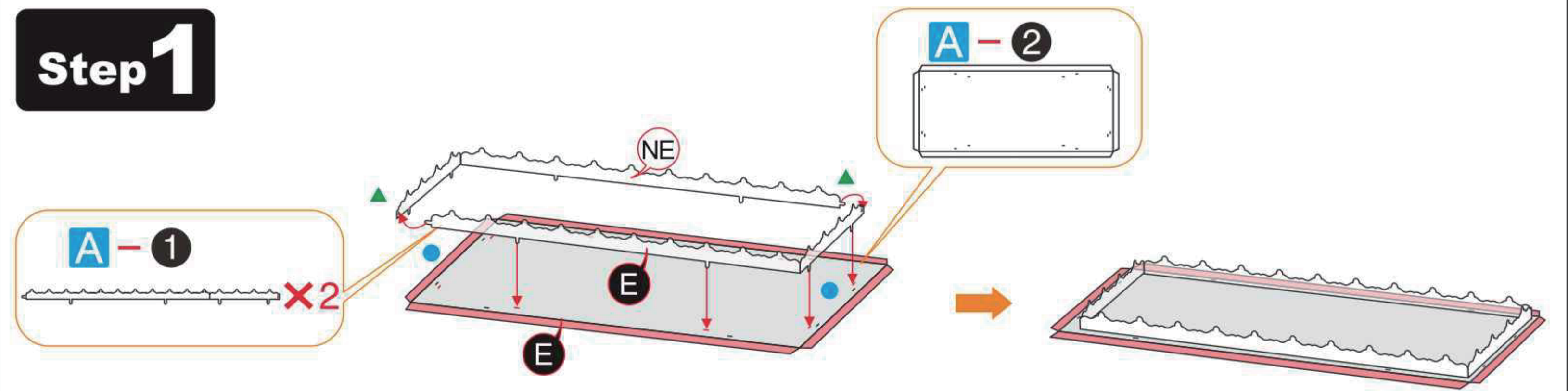

Step 2

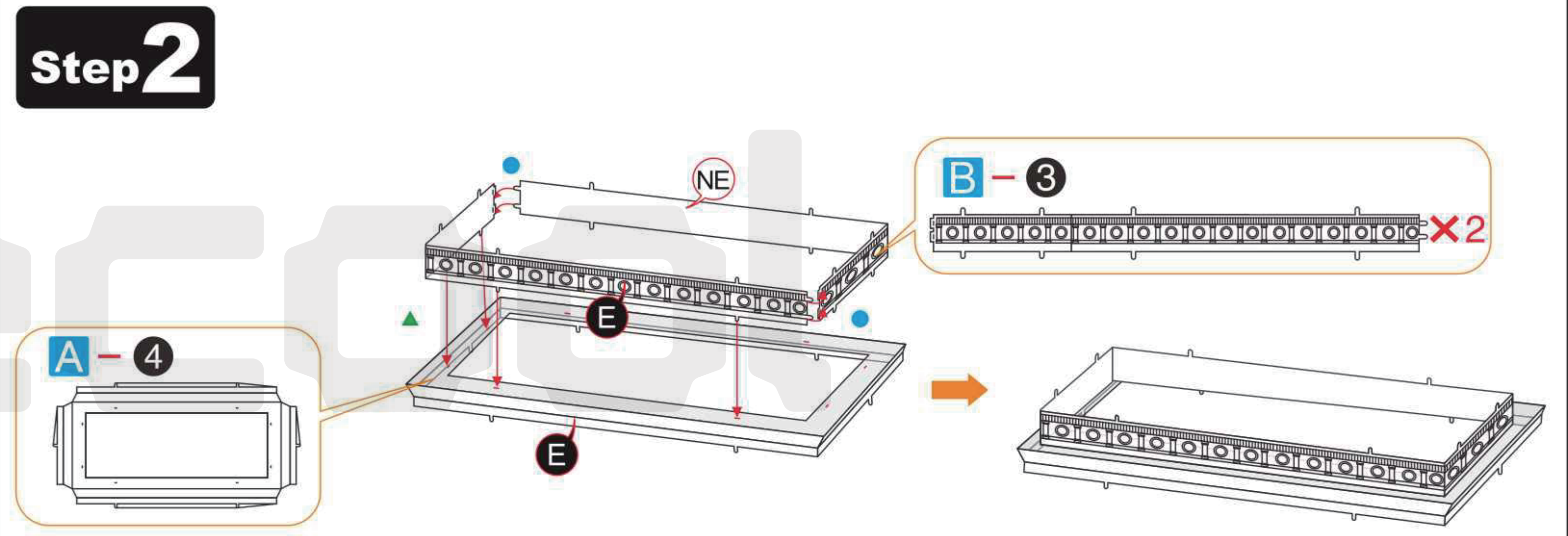

Step 3

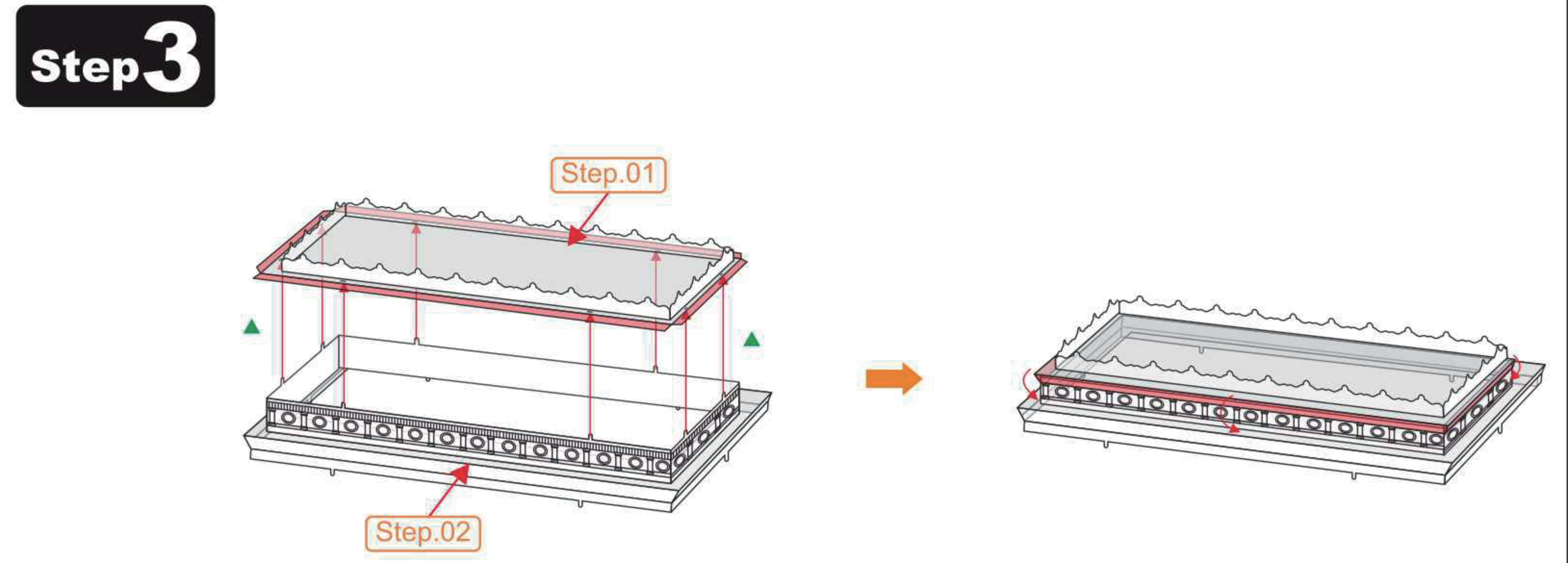

Step 4

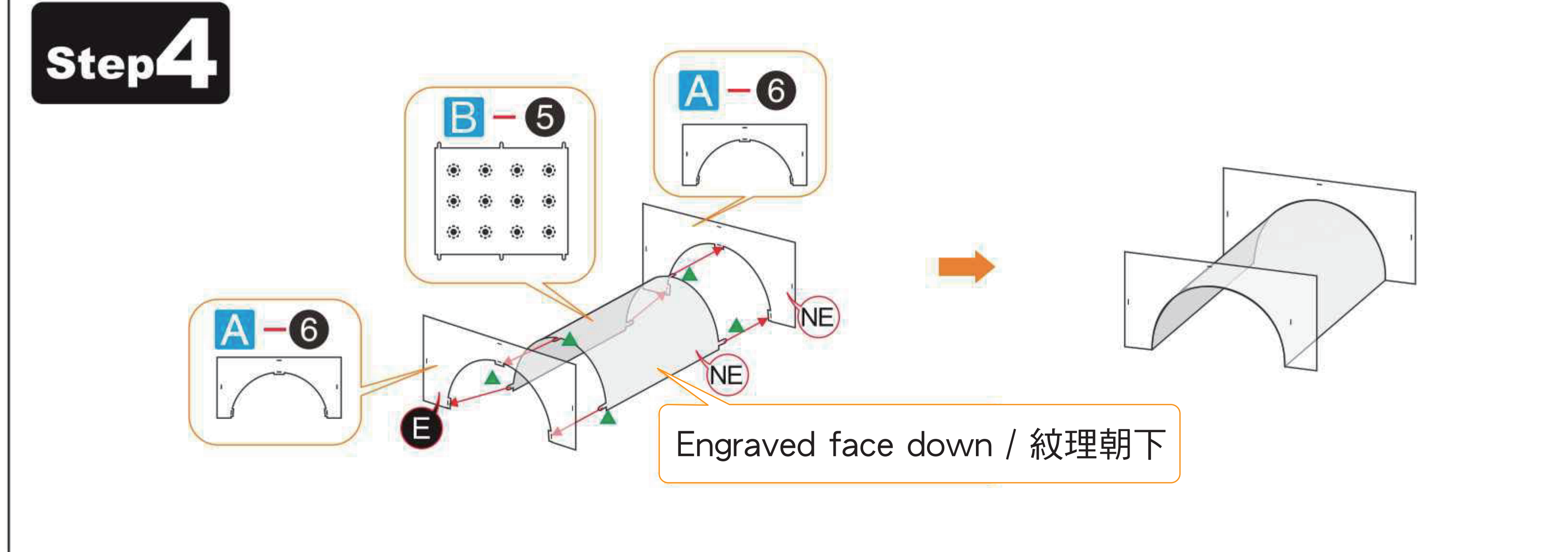

Step 5

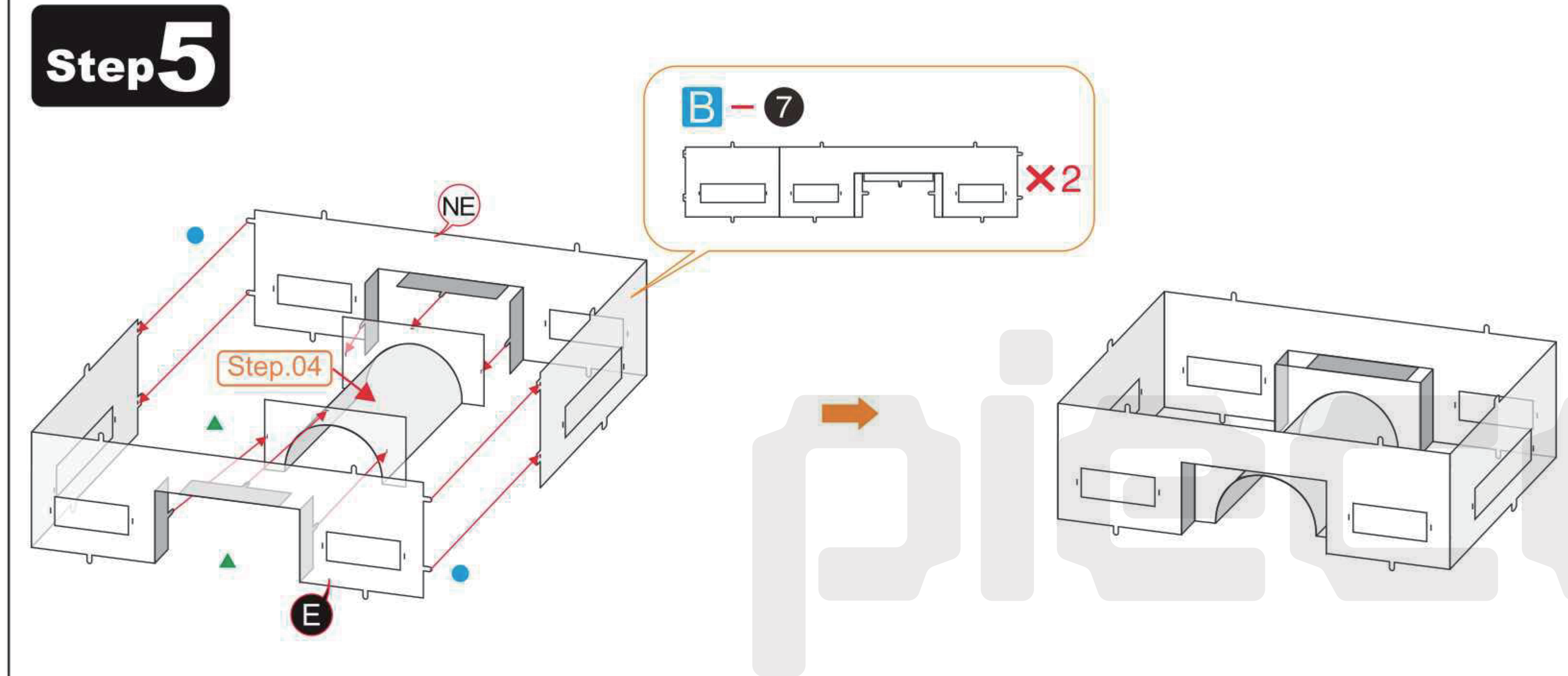

Step 6

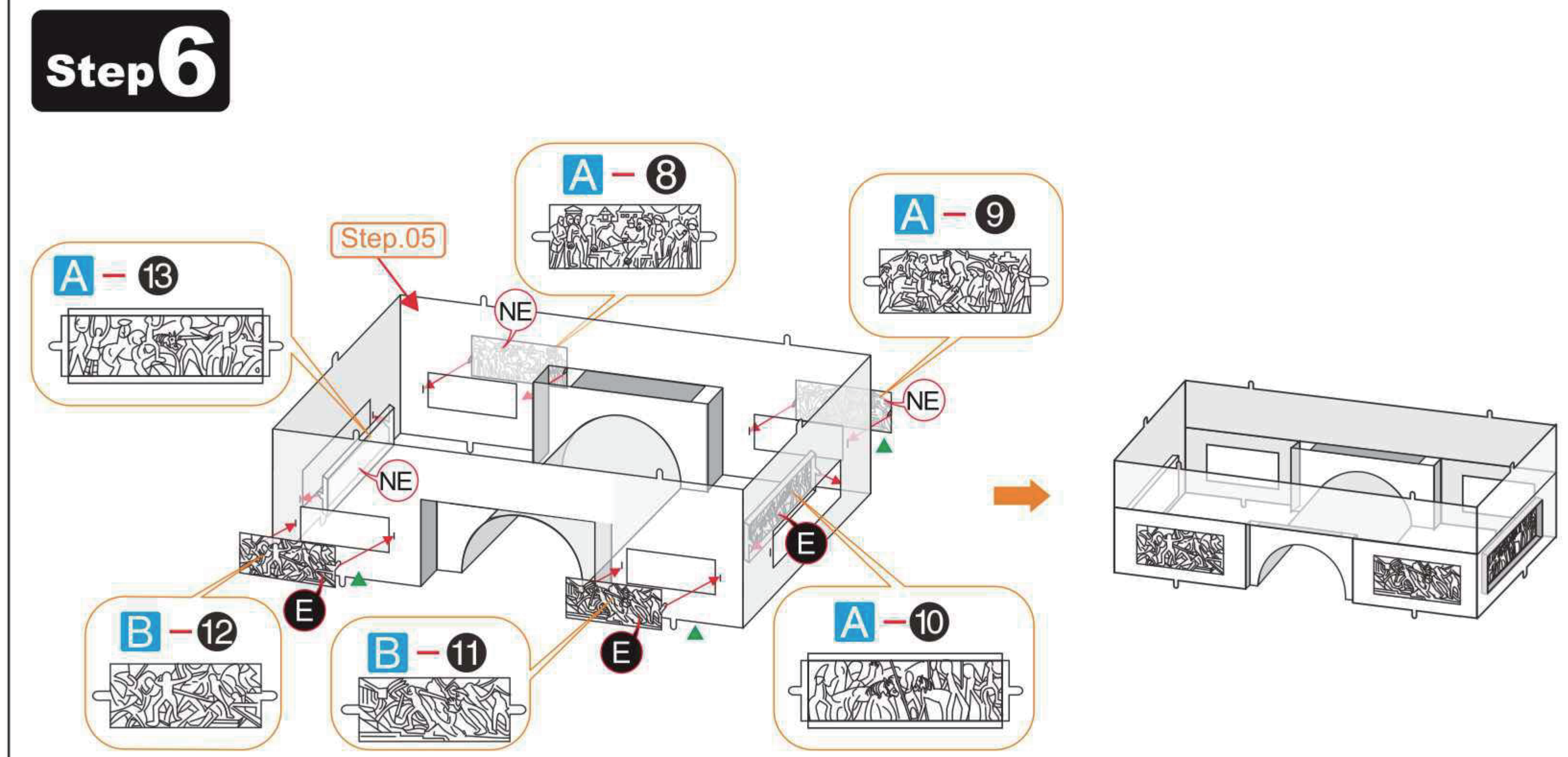

Step 7

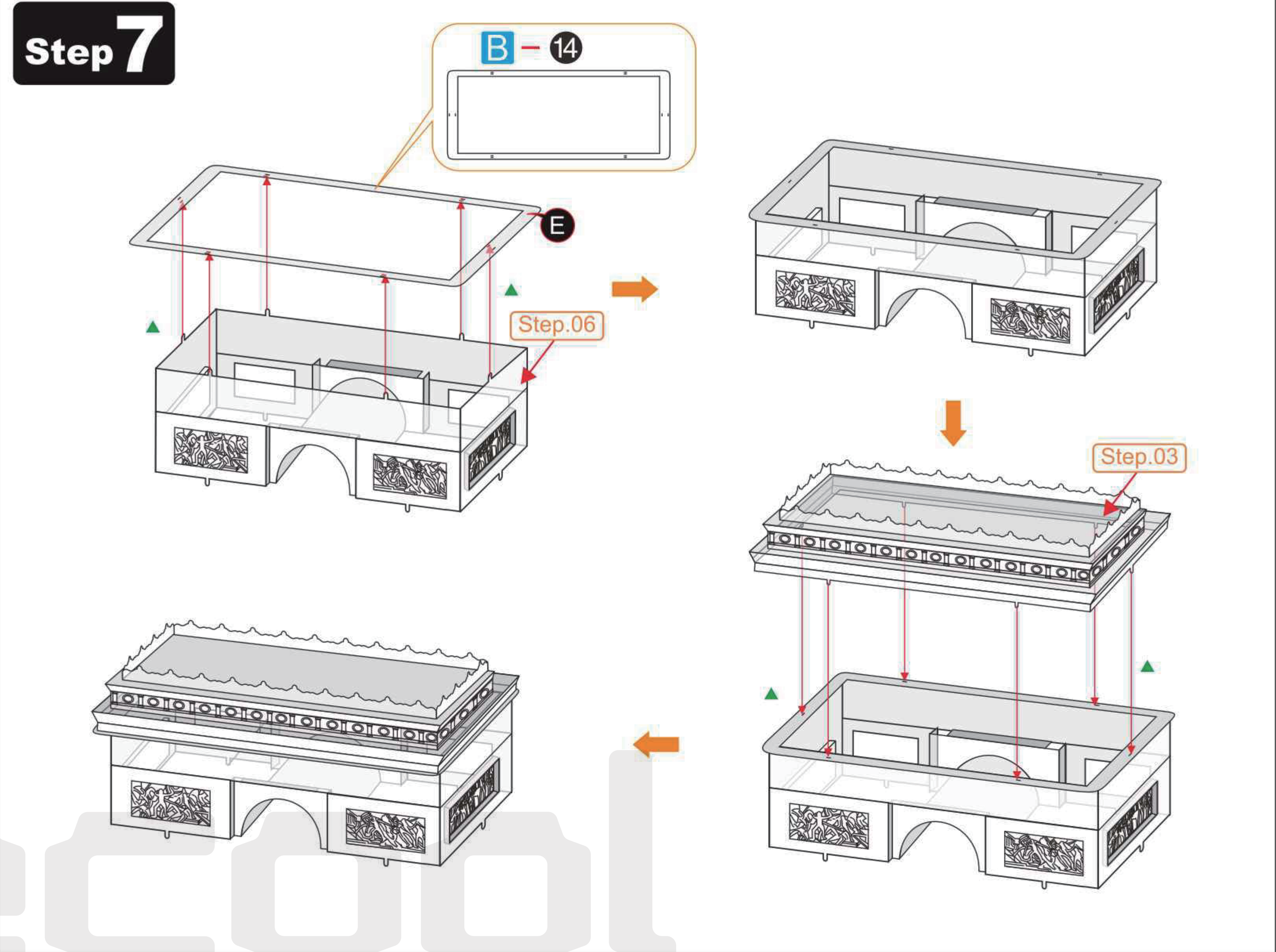

Step 8

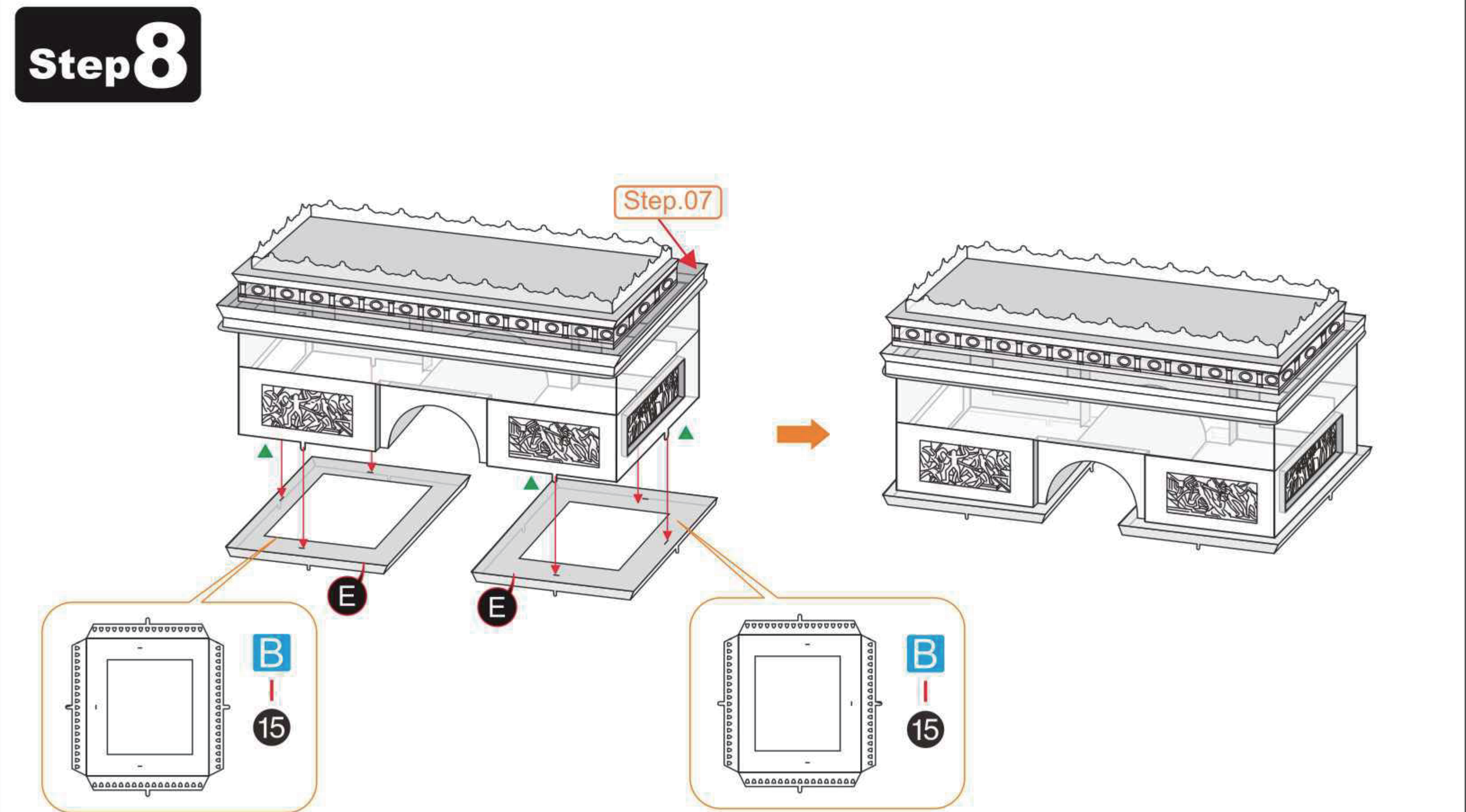

Step 9

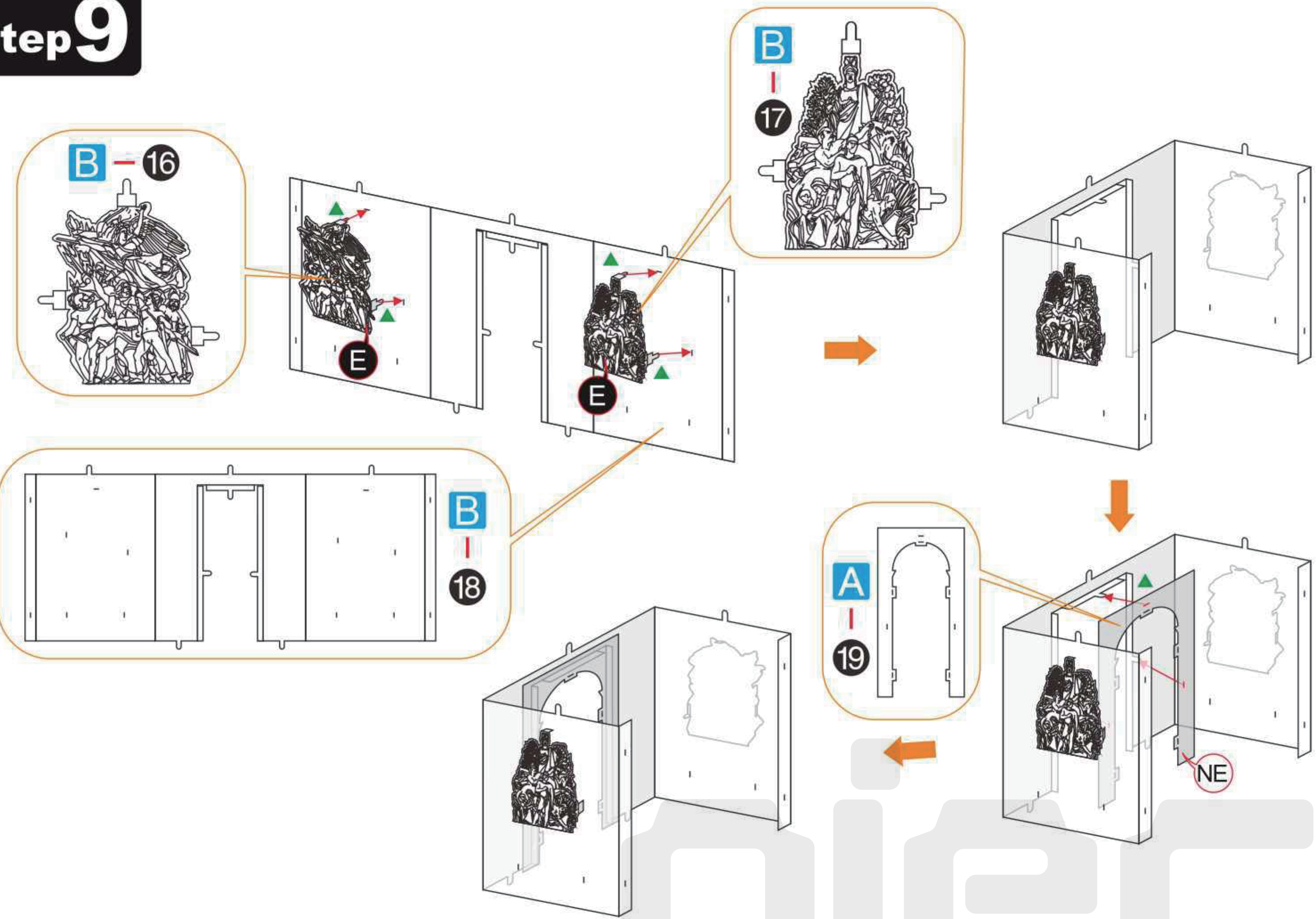

Step 10

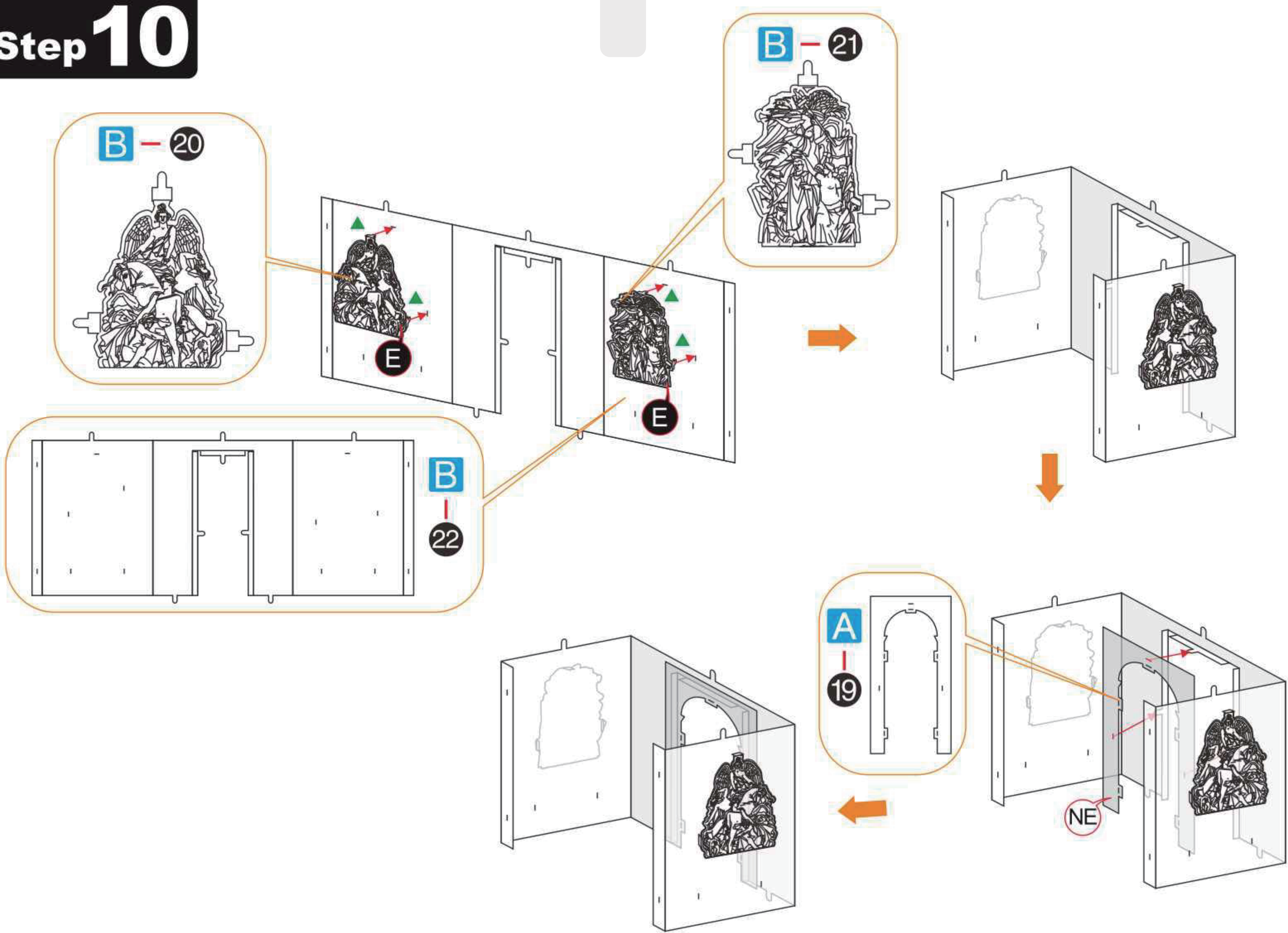

Step 11

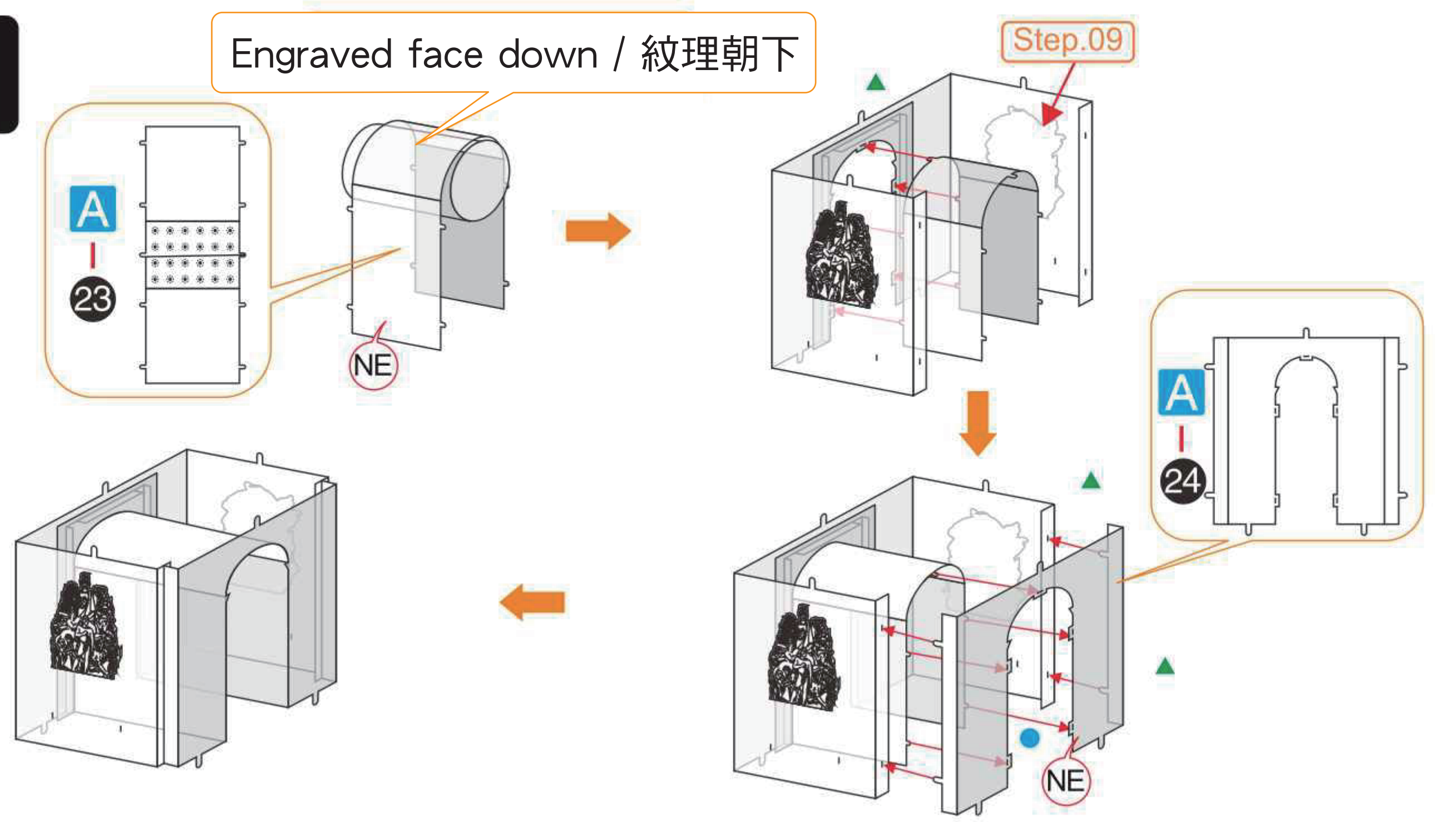

Step 12

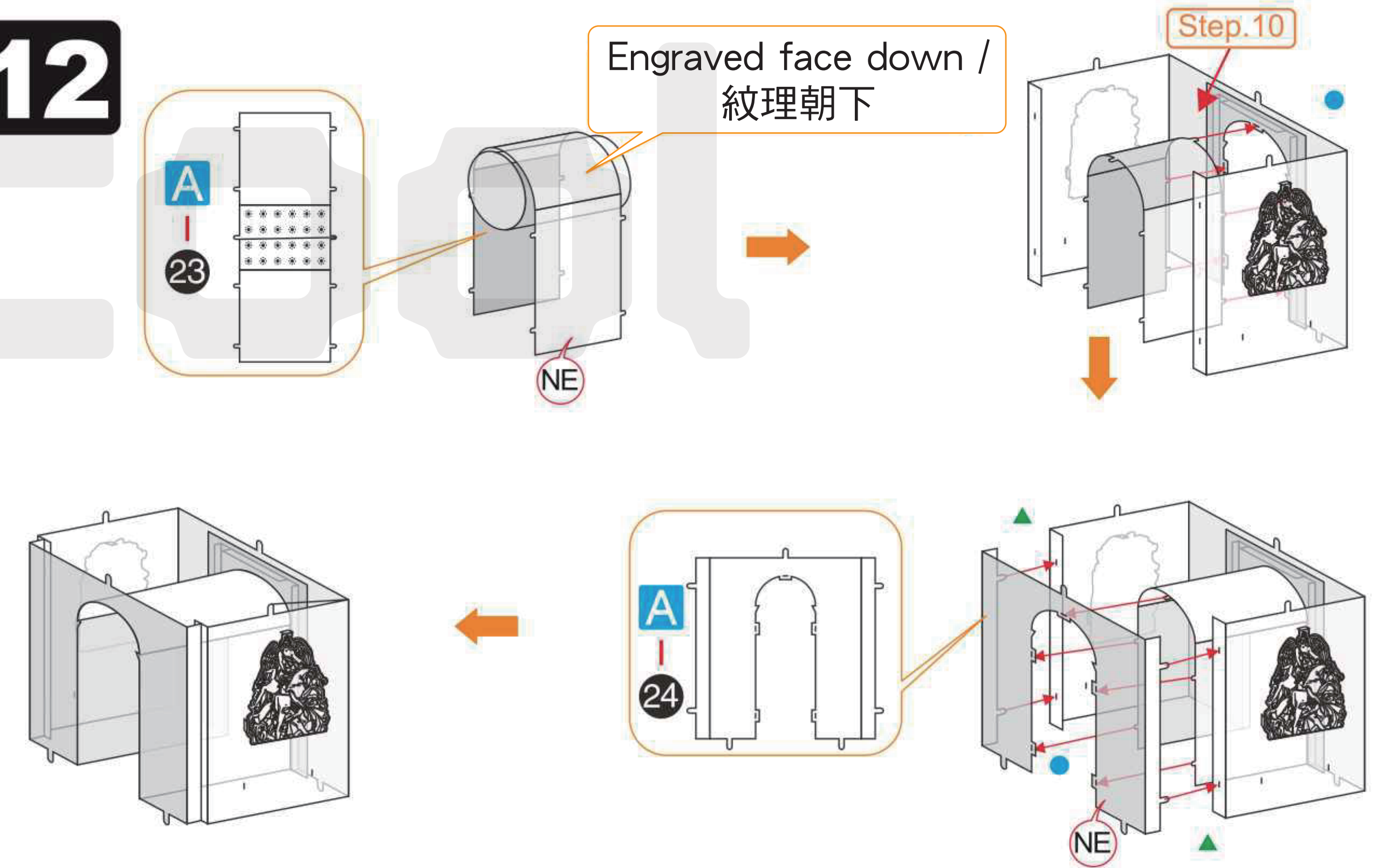

Step 13

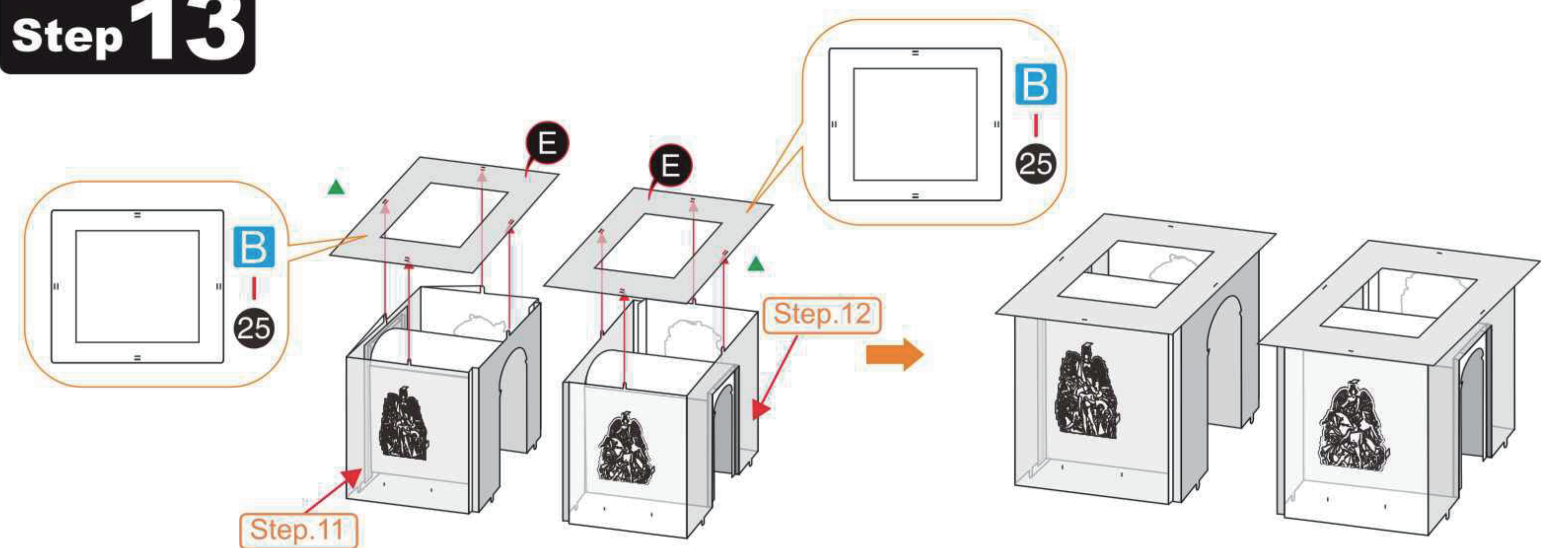

Step 14

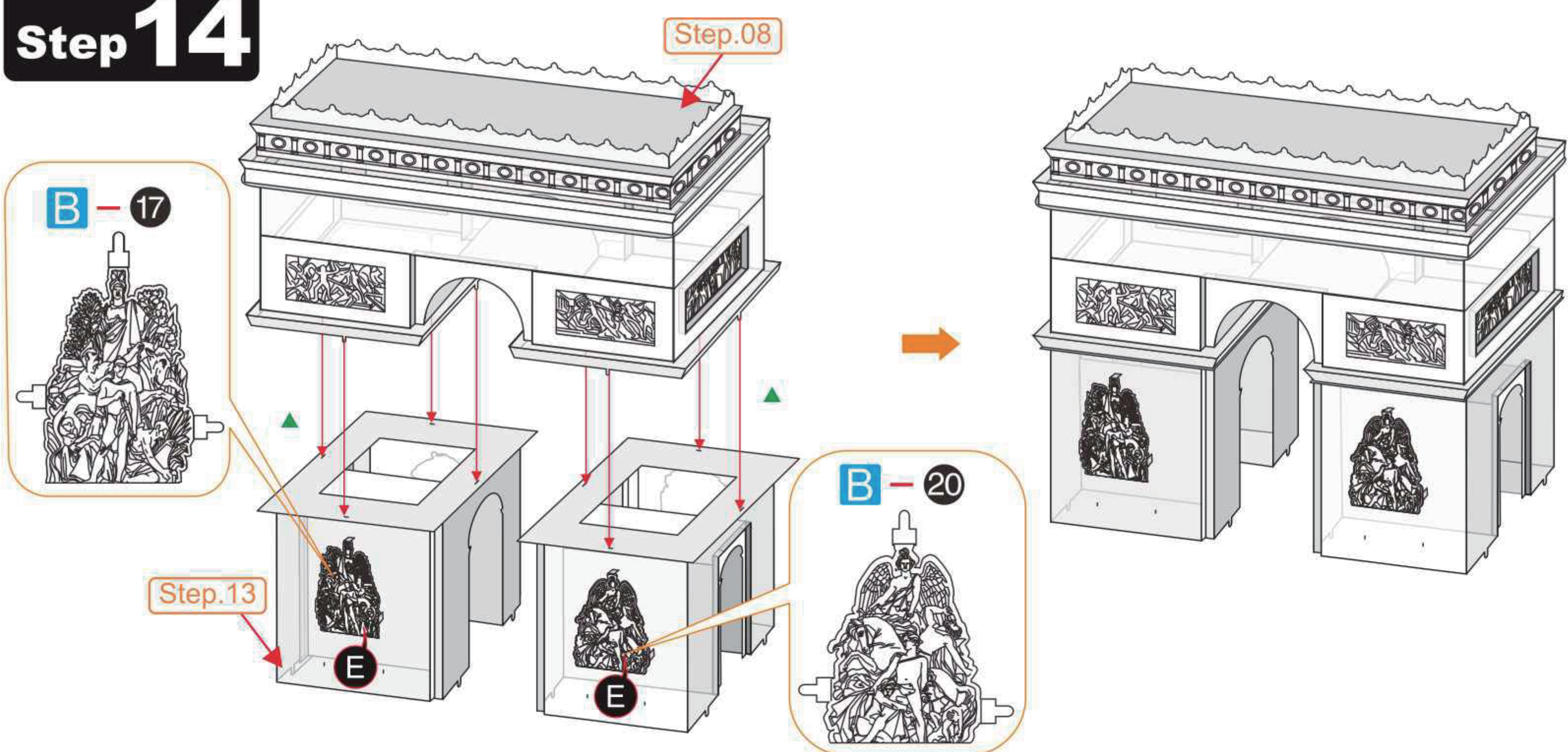

Step 17

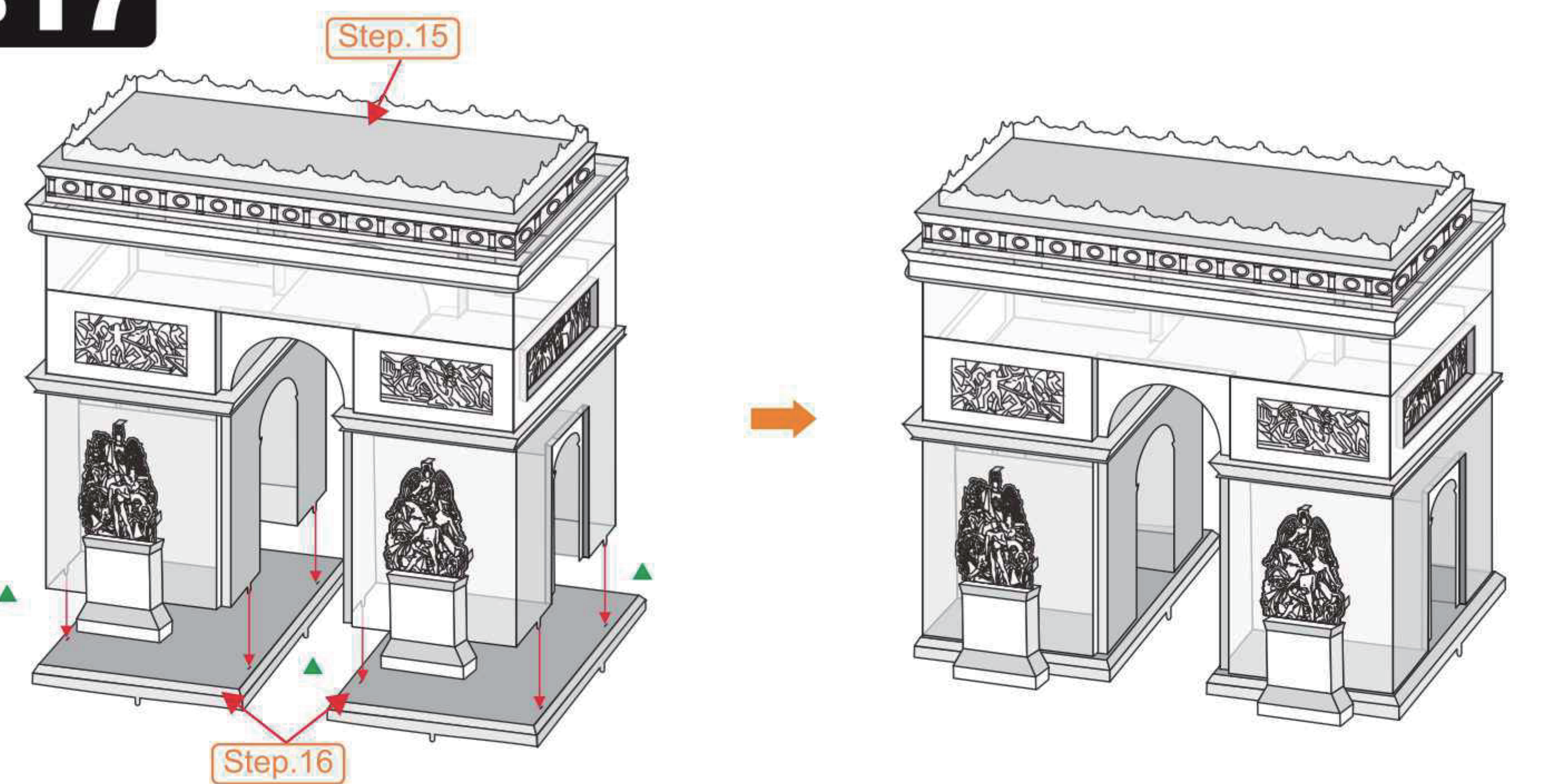

Step 15

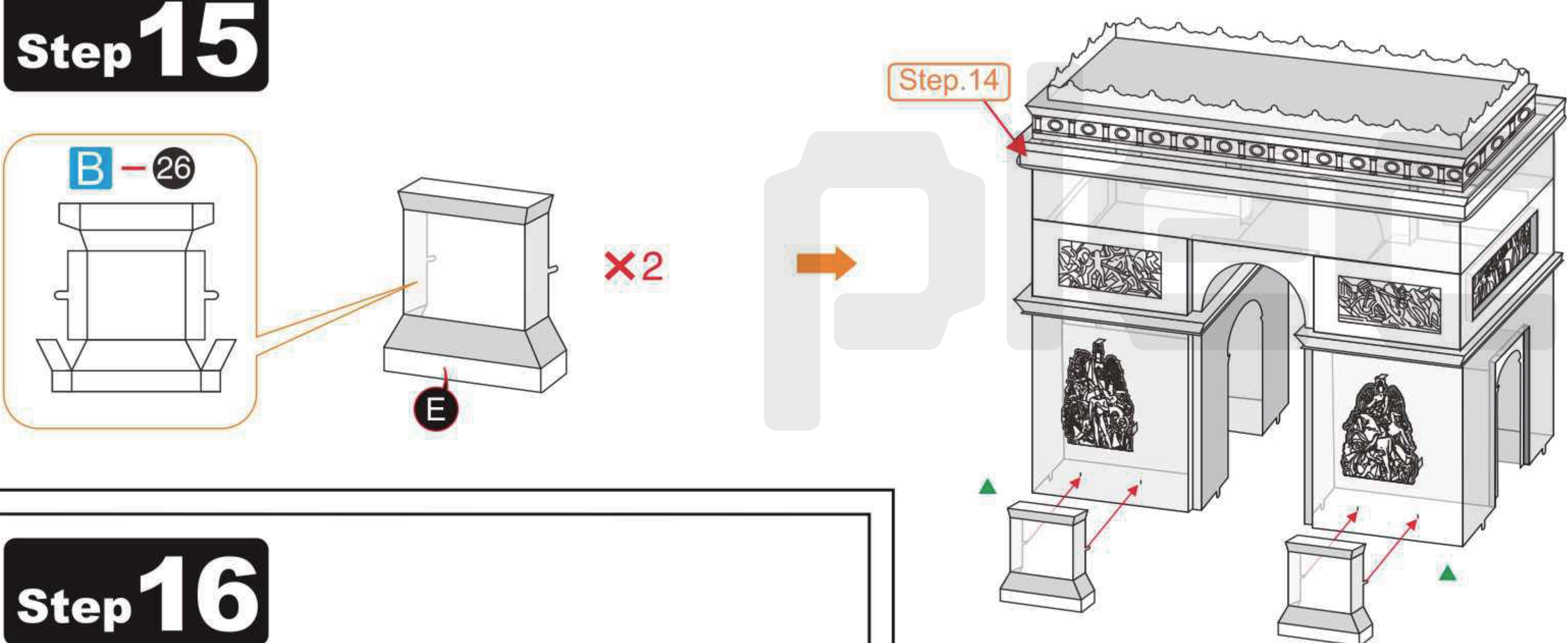

Step 18

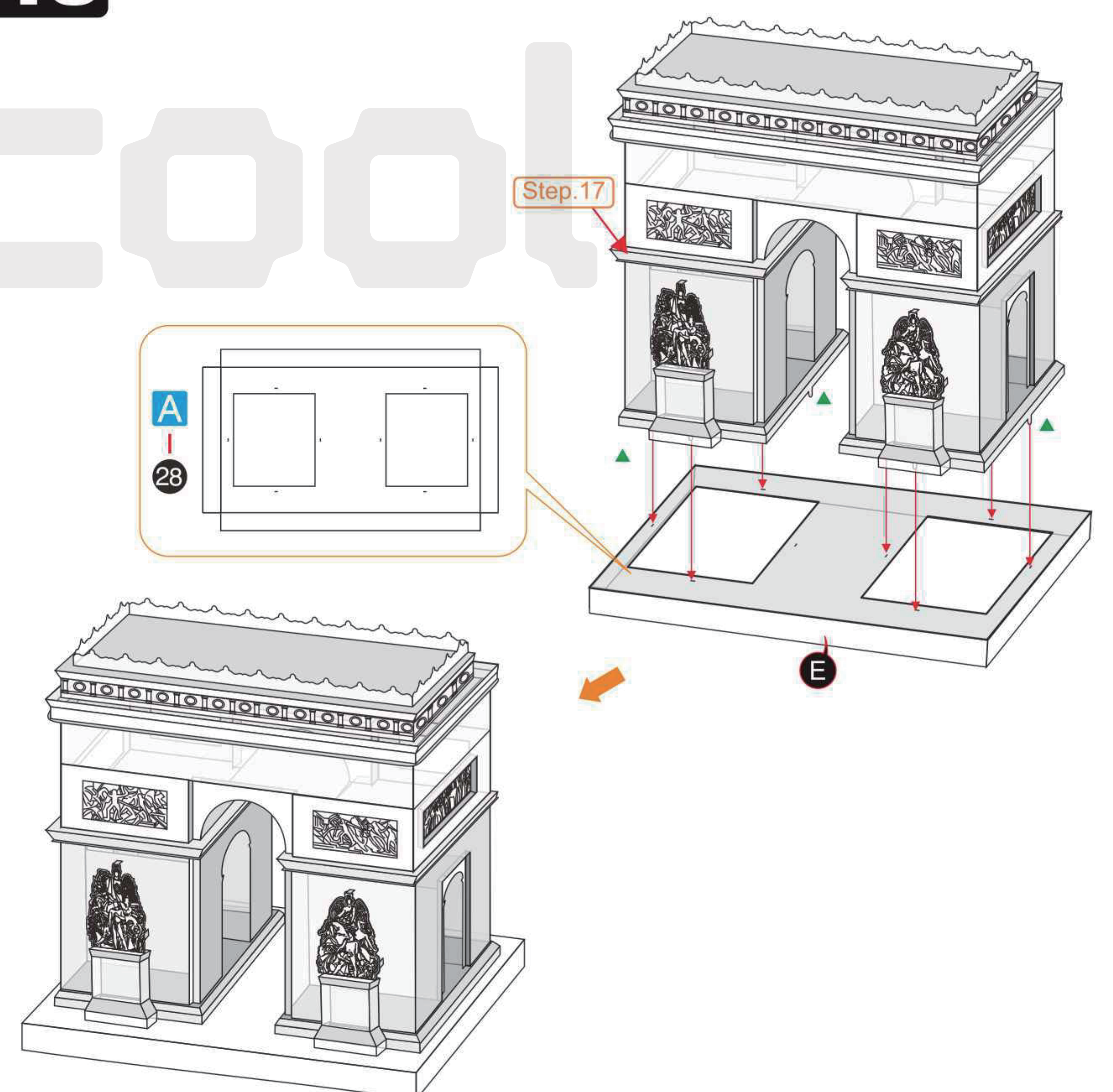

Step 16

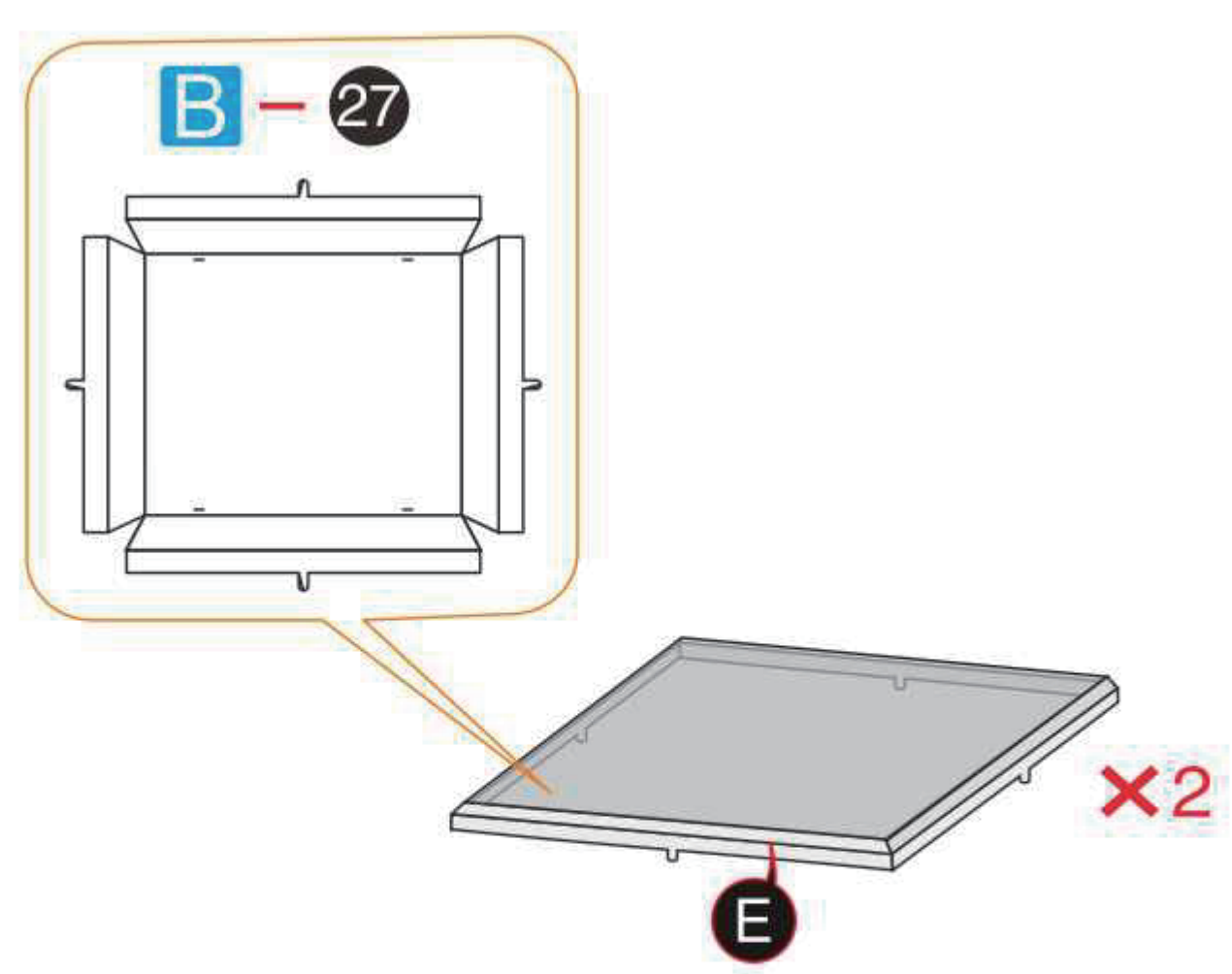

piececool

ARC DE TRIOMPHE 凱旋門 HP008

Metal Sheet / 金屬板板件 Sketch Map / 示意圖

© WIST PLASTIC & METAL TECHNOLOGY LIMITED. ALL RIGHTS RESERVED.

CP-PART-HP008#-A1-2020.07.25

Metal sheet / 金屬板板件

A

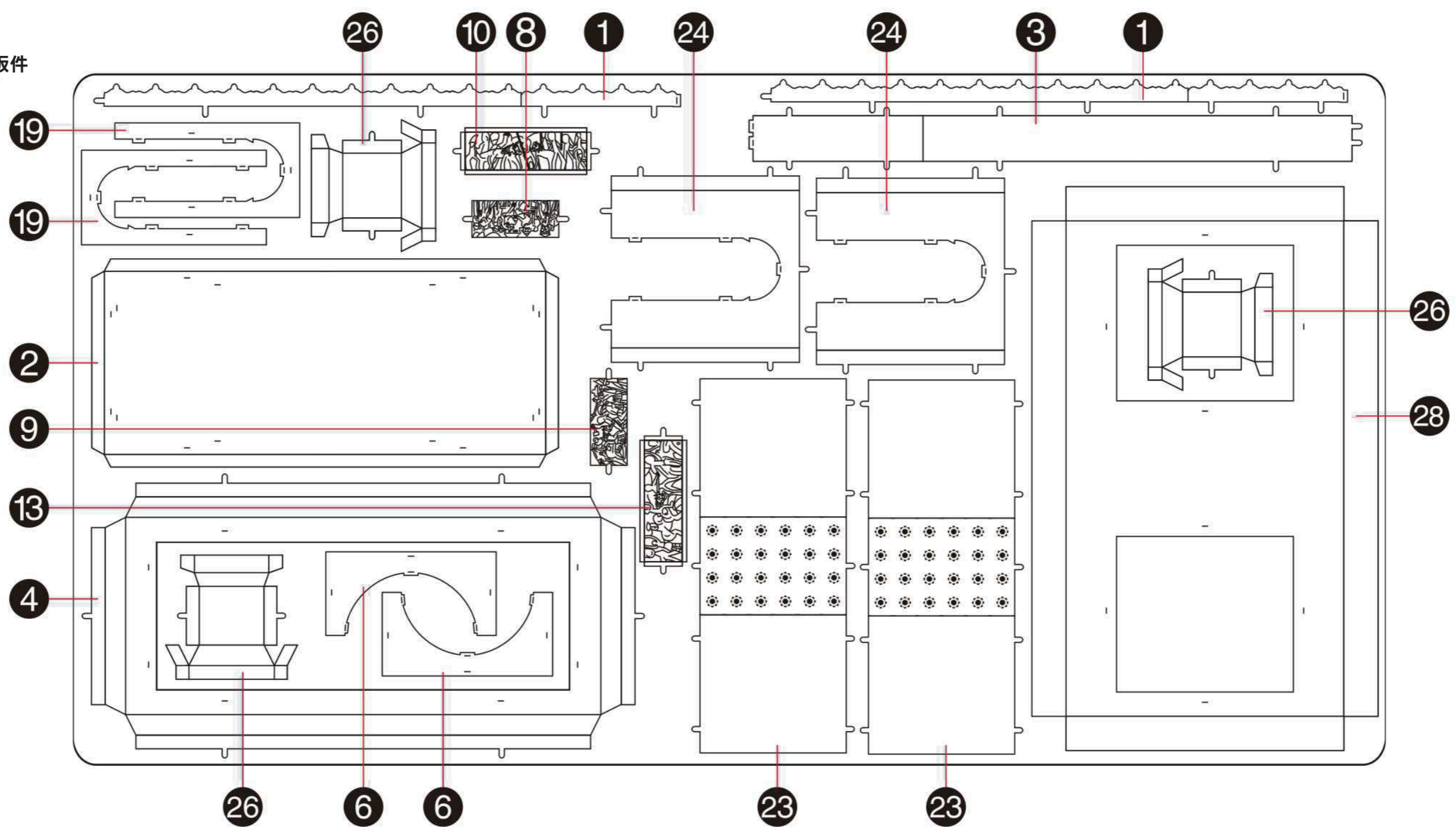

Metal sheet / 金屬板板件

B

